

Digital Super Hybrid System

**Panasonic**

**KX-TD208E**

# Getting Started



**This booklet tells you how to install your KX-TD208 quickly and easily and gives you initial operating instructions. For further information, see the enclosed "Operating Instructions."**

# Contents

---

## **Preparation**

Describes the included accessories and required tools for installation.

Page 3

## **Basic Programming**

Describes the programs necessary depending on your contract and requirements.

Page 6

## **Programming Using A Personal Computer**

Shows you a personal computer connection and how to program by using it.

Page 9

## **Connection**

Shows you how to install your system from set-up to initial use.

Page 4

## **Basic Operations**

Describes how to make and receive calls in order to confirm the connections.

Page 8

## **Assistance Information**

Page 11

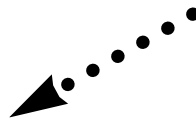
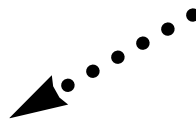

# Preparation

---

## Before installing your system

- ☐ Check the package contents. The included materials are:

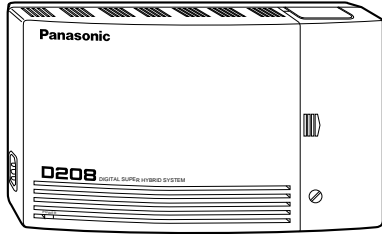

Main Unit ... one

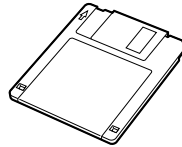

Floppy Disk for PC Programming ... one

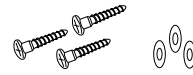

Screws and Washers ... three

\*Do not close the transparent part into the black part before inserting the wires.

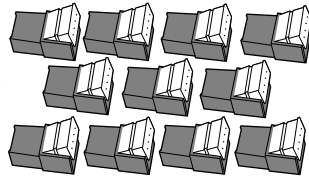

4-pin Plugs\* ... eleven



AC Cord ... one



ISDN Line Cord ... one

- ☐ Necessary user-supplied tools:

- ✓ Phillips screwdriver and flathead screwdriver
- ✓ Electrician's pliers
- ✓ Telephone company contract
- ✓ Serial printer cable to connect a PC to the telephone system
- ✓ Telephone sockets to connect the telephone equipment, if required
- ✓ Wire (solid wire) for the extension connection:

Conductor diameter:       $\varnothing$  0.4 – 0.6mm

Diameter with coating:     $\varnothing$  0.66 – 1.05mm

# Connections

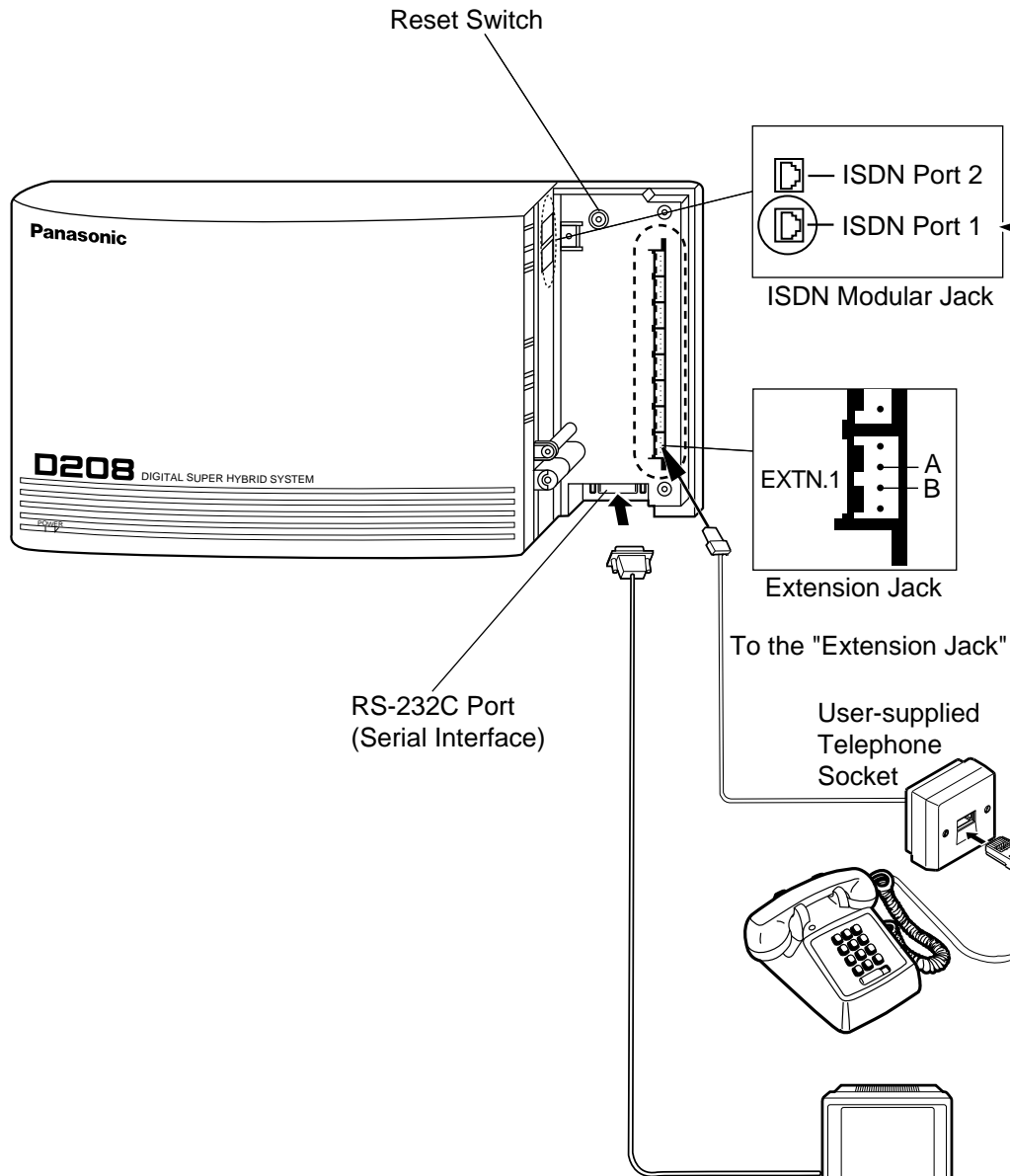

**1. Open the front cover**

**2. Connect the include**

**3. Connect the user -**

**Preparation**

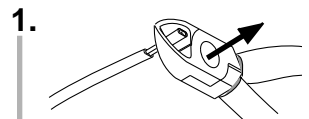

Strip the wire cover with pliers.

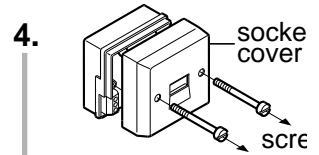

Remove the socket cover with flathead screwdriver.

**4. Connect the PC to**

You can program the system.  
The required operating system

**5. Close the front cover**

To AC Outlet

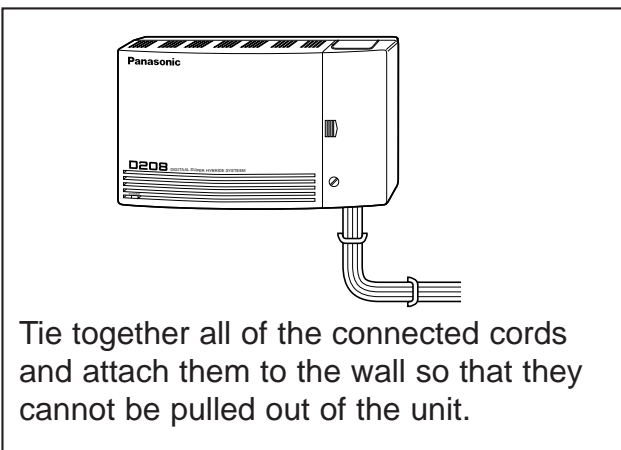
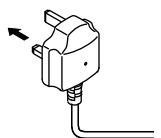

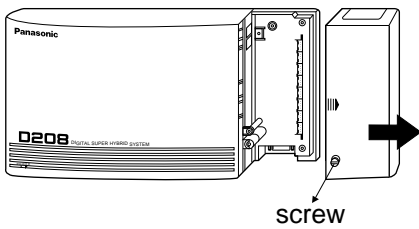

1. Loosen the screw.
2. Slide the cover toward the right while pressing the "III" mark.

Connect the ISDN line cord to "ISDN Port 1" and the Telephone socket to the exchange line.

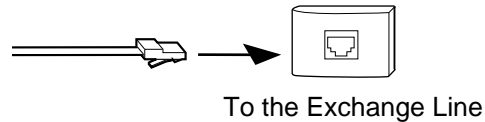

Connect the supplied extension line cord to the "Extension Jack" and telephone equipment.

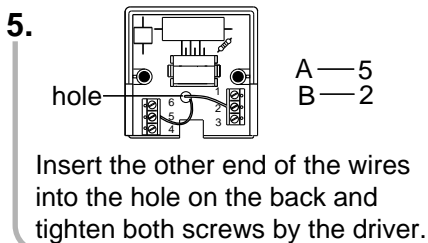
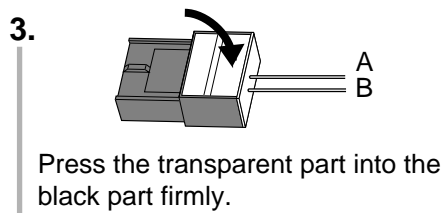
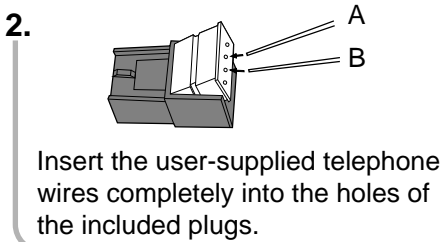

#### Note

For installing proprietary telephones, an optional PT Interface Card (KX-TD20870CE) should be installed on your system. Please refer to the Operating Instructions for details.

The maximum length of the extension line cords to the extensions are;

	Line Diameter	Max. Length
SLT	0.6mm	620m
PT	0.6mm	240m

Connect the AC cord to the RS-232C port.

Use the data using TD208.EXE file in the included floppy disk on the IBM-PC/AT or compatible personal computer (PC). OS) is Version 5.0 or later versions of MS-DOS.

Slide the cover in the direction of the arrow and connect the AC cord to the AC inlet and AC outlet.

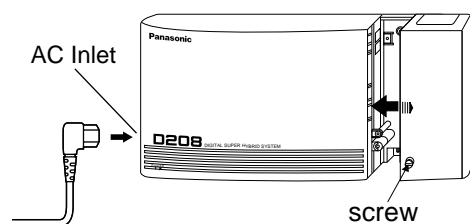

1. Slide the cover in the direction of the arrow.
2. Tighten the screw.

# Basic Programming

Some programming is required for basic operation. Check your contract with the telephone company and program as needed. The following flow chart will tell you which programming is required for your system. Please program your system accordingly.

## Before programming

Connect a tone-type single line telephone to jack number 1 for programming.  
 Check: • Your telephone is on-hook.  
 • No calls are on hold at your telephone.

## Programming type selection

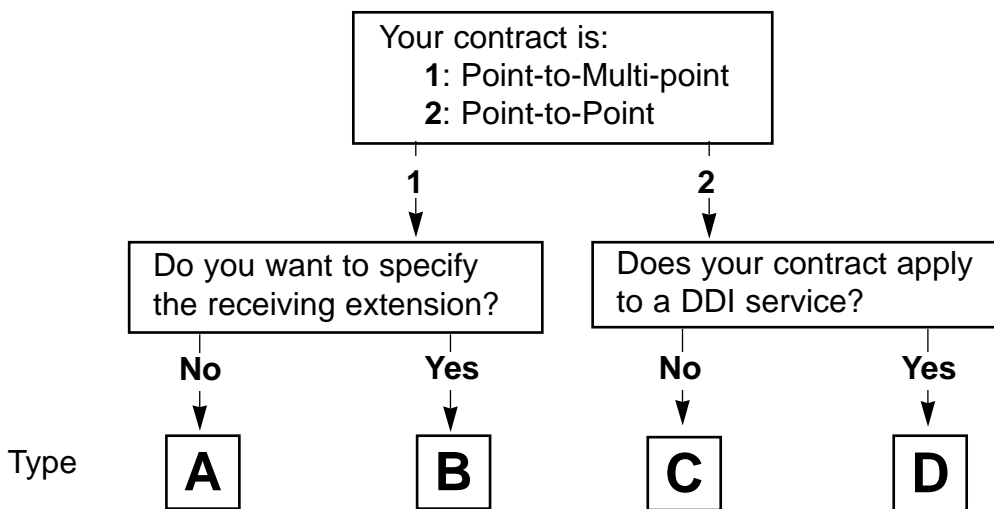

## Programming

**Step 1. Enter into the programming mode.**

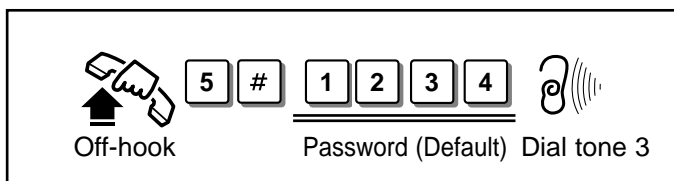

**Step 2. Program [404] to all the types A, B, C, D.**

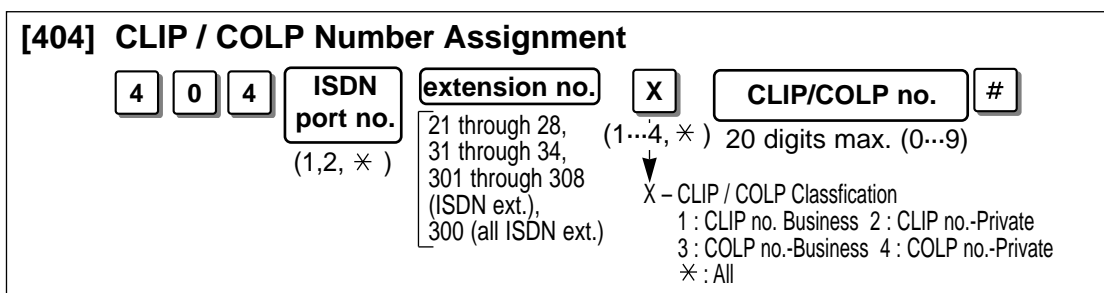

(Continued)

# Basic Programming

Step 3. Follow the chart according to your programming type .

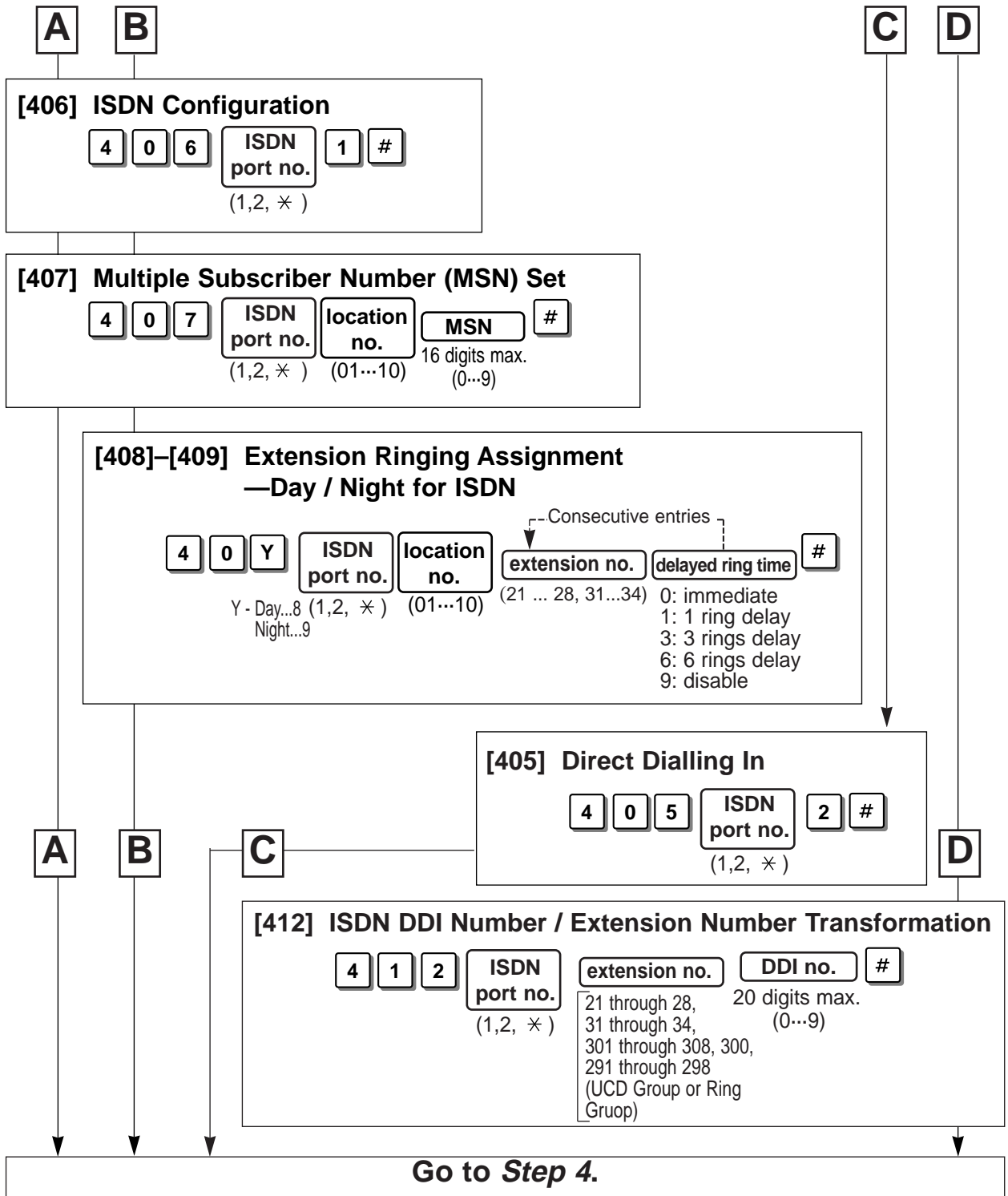

Step 4. Exit from the programming mode.

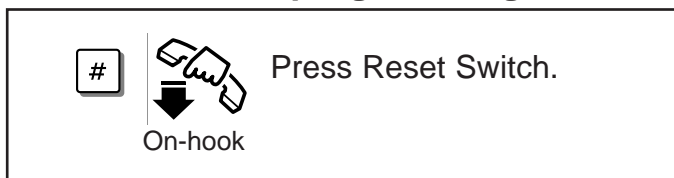

# Basic Operations

---

Let's try to make and receive a call in order to confirm the connections.

## Making a call to another extension and receiving it

- ❑ Making a call from extension 21 to extension 22

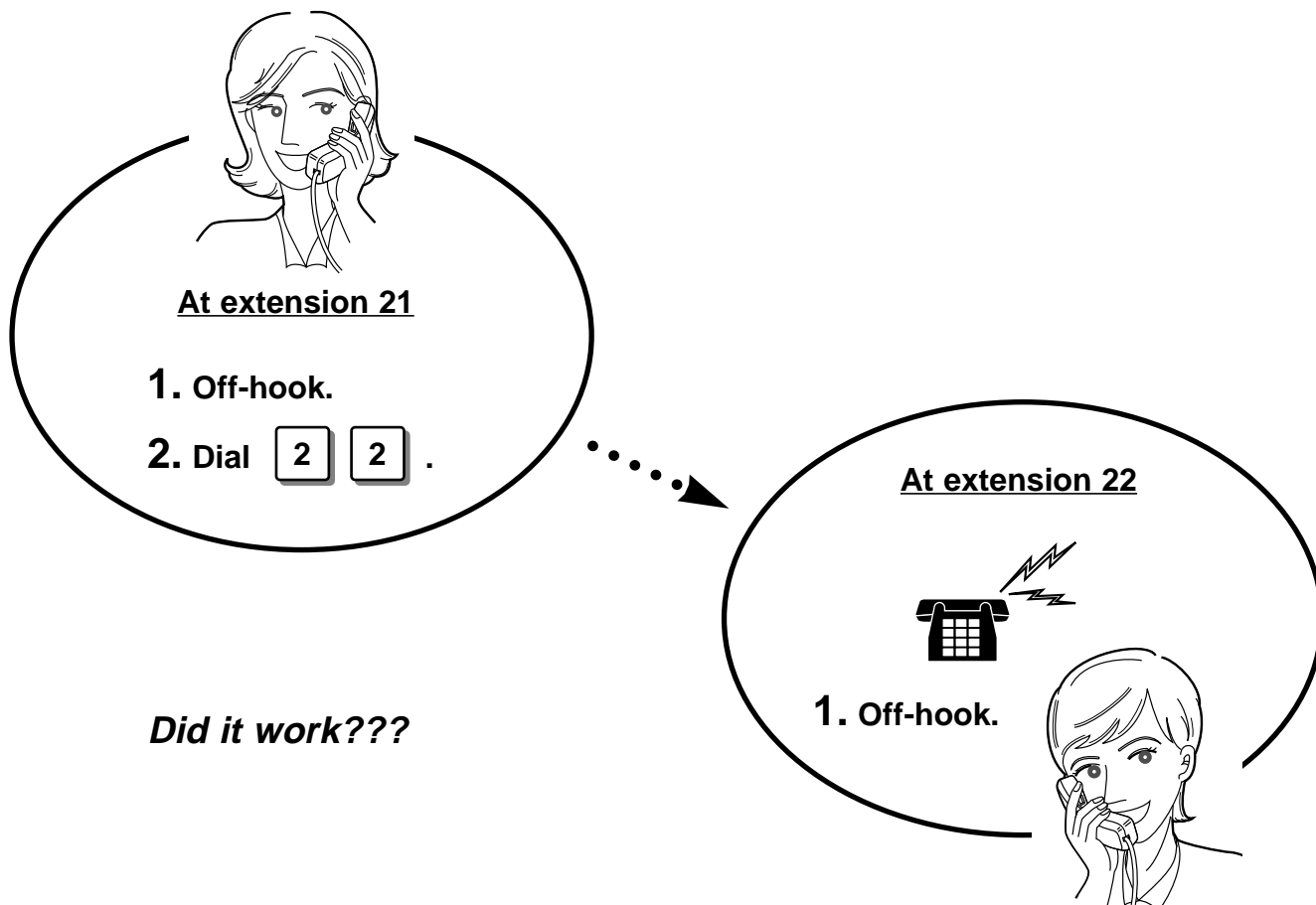

## Making a call to an outside party

- ❑ Calling a Speaking Clock

1. Off-hook.
2. Enter .
3. Dial   .

*Can you hear the time announcement?*

# Programming Using A Personal Computer

## Connection

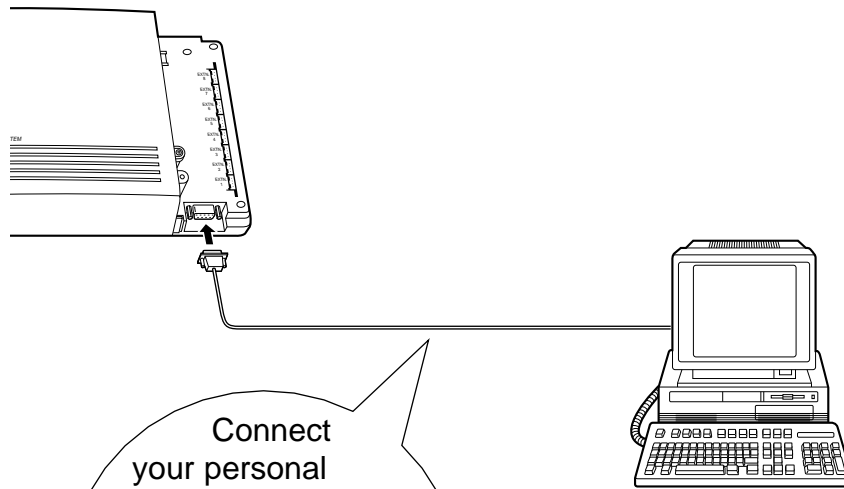

Connect your personal computer to the RS-232C port with the user-supplied serial printer cable. The Cable must be shielded and the maximum length is 2 m.

☐ Refer to the following chart for the pin configuration;

Port on your system		9-pin port on a PC		
Pin No.		Pin No.	Signal Name	Circuit Type (EIA)
2	↔	2	RXD	BB
3	↔	3	TXD	BA
4	↔	4	DTR	CD
5	↔	5	SG	AB
6	↔	6	DSR	CC
7	↔	7	RTS	CA
8	↔	8	CTS	CB

# Programming Using A Personal Computer

---

## Programming

You can program the system data using the application software in the included floppy disk on the IBM-PC/AT or a compatible personal computer. The system programming data can be stored either on the floppy disk or on your hard disk. To use the floppy disk for PC programming, you must have MS-DOS (or equivalent) version 5.0 or later. A minimum of 450K of free conventional memory is required.

### File Configuration

The file name: TD208.EXE (Execution file)

You may store the following files if desired.

**Database file:** \*.DBF

**ASCII file:** \*.DBA

**Screen save file:** P208.PRT



○ The "\*" represents the file name of your choice. (up to 8 characters)

### Setup

1. Insert the floppy disk into drive A.
2. Change the current directory to drive A.
3. Type **TD208** after confirming the sign ">" and press the *Enter* key.
  - The initial screen appears.



- After the initial screen appears, you can remove the included disk and insert a database file disk to save the data.
- If your monitor is monochrome and you cannot see the cursor easily, exit the programming mode and re-type **TD208/MONO**.
- If you need an explanation of the system and its operations, press F4 (Help) on the initial screen. A Help screen will appear.
- This program is guaranteed to work with MS-DOS only. It is not guaranteed with MS-DOS in Windows.

# Assistance Information

---

If you have any trouble, see the Trouble Shooting Section in the Operating Instructions or consult your dealer.

