

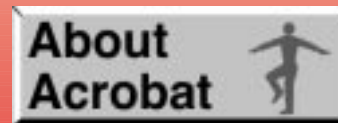

# Digital System DS

## Multibutton Telephone Feature Handbook

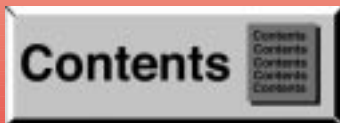



- In **Edit** ⇨ **Preferences** ⇨ **General**, set the following:
  - **Default Magnification** = Fit Width
  - **Display Splash Screen at Startup** = Disabled (box not checked)
  - **Display Open Dialog Box at Startup** = Disabled (box not checked)
- For easiest reading on-screen, select **View** ⇨ **Fit Width** (or **Ctrl K**). This option is automatically enabled if you set the *Default Magnification* in General Preferences as described above.
- To return to the opening screen at any time, press **Home**.  
To scroll up or down on a page, press **PageDown** or **PageUp**.  
To navigate between pages, press **→** or **←**.
- To increase the speed with which your Acrobat files load, try one of the following:
  - In **Windows 3.1**, add *ACROREAD.EXE* to your **Startup Group** (with the Run Minimized box checked).
  - In **Windows 95**, add *ACROREAD.EXE* to the **Windows\Start Menu\Programs\StartUp** folder (with Run Minimized selected).  
*You'll have to maximize the first Acrobat file you run.*



- Provides on-line viewing and printing.
- Extensive search and navigation capabilities.
- Ensures more timely turnaround of documents.
- When we provide an Acrobat manual with a product (e.g., Nitsuko TAPI Driver), you are assured of having the most up-to-date manual available.
- With the installation of a PC fax/modem, it makes faxing of any brochure, user guide, proposal or manual quick and easy.
- Acrobat Reader programs for Macintosh, DOS and UNIX platforms also can be provided, if required.
- For Technical Support for the Acrobat Reader, contact:

**Adobe Systems, Inc.**

1585 Charleston Road

P.O. Box 7900

Mountain View, CA 94039-7900

Telephone Number: 415-961-4400

Adobe FaxY1 (technical/product information by fax): 206-628-5737

Adobe Electronic Bulletin Board (on-line information): 206-623-6984

URL: <http://www.adobe.com>

- To return to the opening screen, press the **HOME** key.

# Contents

- Using Your Telephone
- Basics
- Features

# Table of Contents

Your system may restrict you from using some of the features listed in this handbook. Ask your communications manager which features you can use. Then, check in the box next to the feature's name. Also, if your system does not use the standard numbering plan, feature access codes may be different than described.

<b>Using Your Telephone</b> .....	<b>1</b>
Your multibutton telephone .....	1
Using a programmable key with three functions .....	1
If your phone has an alphanumeric display .....	2
Your phone's key lights .....	2
Using Handsfree instead of the handset .....	3
Dialing codes to use features .....	3
If you have a DSS Console .....	4
Customize with user-programmable features .....	4
<b>Basics</b> .....	<b>7</b>
Handsfree .....	7
Outside Calls .....	7
Intercom Calls .....	9
Hold .....	10
Transfer .....	12
<b>Features</b> .....	<b>14</b>
Account Codes .....	14
Alarm .....	15
Alternate Attendant .....	16
Automatic Call Distribution .....	17
Background Music .....	19
Call Forwarding .....	20
Call Forward System Cancel .....	21
Call Timer .....	21
Callback .....	22
Caller ID .....	23

---

Camp-On . . . . .	24
Conference . . . . .	25
Conference, Unsupervised . . . . .	26
Dialing Number Preview . . . . .	26
Direct Station Selection . . . . .	27
Directed Call Pickup . . . . .	28
Directory Dialing . . . . .	29
Display Messages . . . . .	30
Do Not Disturb . . . . .	31
Door Box . . . . .	31
Flash . . . . .	32
Forced Line Disconnect . . . . .	33
Group Call Pickup . . . . .	33
Group Listen . . . . .	34
Group Ring . . . . .	34
Headset . . . . .	35
Hotline . . . . .	36
Intrusion (Barge-In) . . . . .	37
Last Number Redial . . . . .	38
Line Callback . . . . .	38
Meet-Me Conference . . . . .	39
Message Waiting . . . . .	40
Microphone Mute . . . . .	41
Monitor . . . . .	41
Night Answer . . . . .	42
Off-Hook Signaling . . . . .	43
Operator Assistance . . . . .	44
Page, Zone . . . . .	45
Park . . . . .	47
Personal Greeting . . . . .	48
Prime Line Selection . . . . .	49
Privacy Groups . . . . .	50
Removing Lines and Extensions . . . . .	50
Ringling Line Preference . . . . .	51
Save . . . . .	51
Selectable Display Messages . . . . .	52
Speed Dial . . . . .	53
Station Call Coverage . . . . .	59

---

Telemarketing Dial . . . . .	61
Time and Date . . . . .	61
Voice Mail . . . . .	62
Voice Prompting Messages . . . . .	65
Volume Controls . . . . .	67
Walking Class of Service . . . . .	68
Charts and Illustrations . . . . .	69



# Using Your Telephone

## Your multibutton telephone . . .

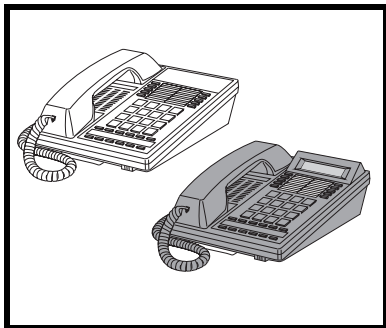

Your multibutton telephone, available in taupe or graphite, gives you quick access to your system's features. For example, place or answer a Message Waiting just by pressing MSG. Or, press DND to quickly put your phone in Do Not Disturb. If a call is ringing your phone, all you have to do is press the flashing line key to answer it. For an illustration of all the keys on your phone and what they do, turn

to page 72 at the back of this guide.

## Using a programmable key with three functions . . .

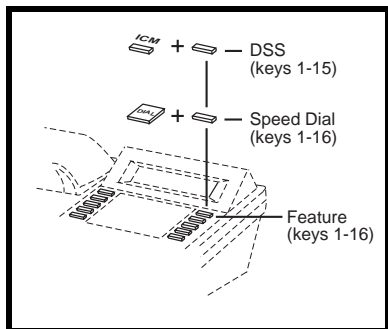

Your multibutton telephone has 16 programmable keys. Each of your programmable keys may have up to three functions. A single key can be a line, Speed Dial *and* Direct Station Selection (DSS) key. When you just press the key, you get its first level function (e.g., line key). When you press ICM, the key automatically turns into a DSS key. Press DIAL, and the key becomes a Speed Dial key.

Your communications manager can tell you the functions of your programmable keys.

## If your phone has an alphanumeric display . . .

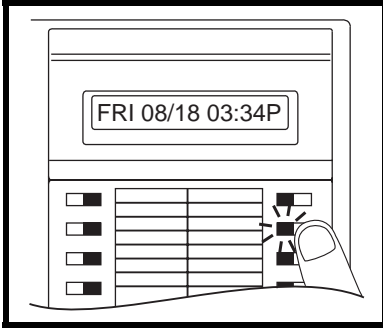

Your telephone's Alphanumeric Display helps you use features and tells you about your calls. For example, a ringing outside line may show you the number of the caller before you answer. You can also adjust the brightness of your display. To find out how, turn to page 30.

## Your phone's key lights . . .

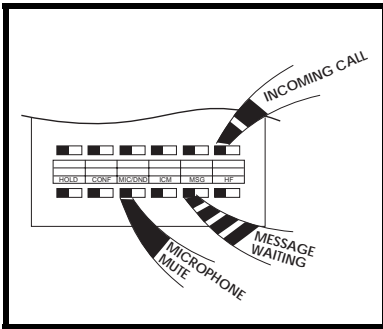

The lights in your phone's keys help you use the features. The way they flash tells you about your call. Depending on the model of your phone, your key lights can be red or both red and green. To find out more about your key lights, turn to page 70 in the charts section at the back of this guide.

## Using Handsfree instead of the handset . . .

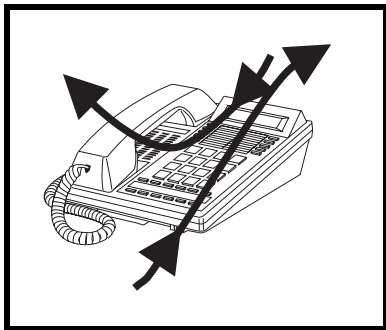

Your telephone may have a Speakerphone for Handsfree operation. This means you can place and answer calls just by pressing HF. If your phone has Automatic Handsfree, you can press a line key for a Handsfree call without first pressing HF. With Monitor, you can press HF to place a call but must lift the handset to talk or answer. Turn to page 7 for more on using the

Handsfree options.

## Dialing codes to use features . . .

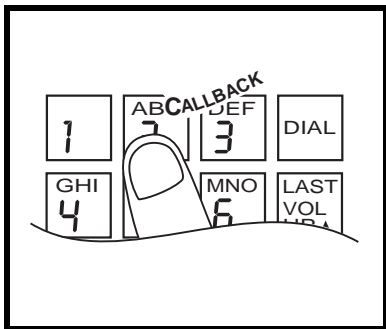

You can call co-workers, place outside calls and use many features by dialing feature access codes. Often, the code you dial is the first letter in the feature's name. For example, dial **C** to leave a *Callback* on a busy co-worker's phone. To find out the codes to dial for outside lines and co-workers, turn to the chart on page 69.

## If you have a DSS Console . . .

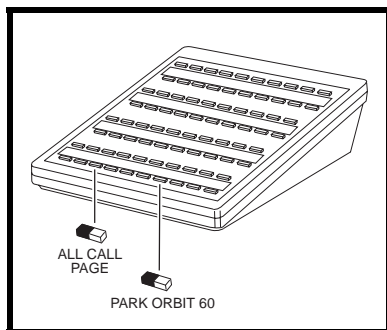

You may have a DSS Console next to your phone. When you first use your DSS Console, many of the keys are programmed for you. By just pressing a key, you can easily call (Hotline) co-workers, Park calls or use Page. For an illustration of the initial layout of your DSS Console, turn to page 73. To find out more on what your DSS Console can do, talk to your communications manager.

## Customize with user-programmable features . . .

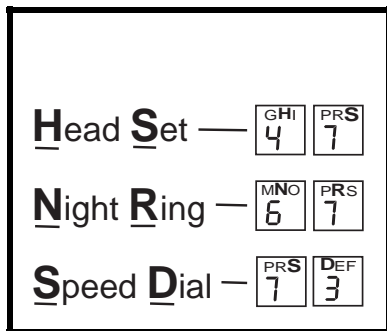

You can customize selected features from your phone. For an easy-to-use chart that shows your customizing options, turn to page 76 in the charts section at the back of this book. Ask your communications manager if you have an access level that allows user-programming.

The symbol  in this guide marks all user-programmable features.

## Know when to use your features . . .

Look up what you want to do	Then turn to page 
<b>Calling a co-worker</b>	Intercom Calls ..... 9 Paging ..... 45 Door Box ..... 31
<b>Outside calls</b>	Placing and Answering ..... 7 Prime Line Selection ..... 49 Ringing Line Preference ..... 51 Account Codes ..... 14 Dialing Number Preview ..... 26 Call Timer ..... 21 Flash ..... 32
<b>Handling and rerouting your calls</b>	Handsfree ..... 7 Hold ..... 10 Transfer ..... 12 Park ..... 47 Call Forwarding ..... 20 Selectable Display Messages ..... 52 Volume Controls ..... 67
<b>When your call can't go through</b>	Camp-On ..... 24 Off-Hook Signaling ..... 43 Callback ..... 22 Line Callback ..... 38 Message Waiting ..... 40 Voice Mail ..... 62 Whisper Page ..... 43 Intrusion ..... 37
<b>The power of digital voice processing</b>	Personal Greeting ..... 48 Operator Assistance ..... 44 Voice Prompting Messages ..... 65
<b>Placing calls quickly</b>	Speed Dial ..... 53 Last Number Redial ..... 38 Save ..... 51 Directory Dialing ..... 29

## Know when to use your features . . .

Look up what you want to do	Then turn to page 
<b>When you work in groups</b>	Privacy Groups..... 50
	Group Call Pickup ..... 33
	Group Ring..... 34
	Directed Call Pickup..... 28
<b>If you need privacy</b>	Do Not Disturb..... 31
	Microphone Mute ..... 41
	Headset..... 35
	Background Music ..... 19
<b>Have a telephone meeting</b>	Conference ..... 25
	Unsupervised Conference ..... 26
	Group Listen ..... 34
	Meet Me Conference..... 39
<b>Streamlining your telephone</b>	Hotline..... 36
	Direct Station Selection ..... 27
	Station Call Coverage ..... 59
<b>Advanced call processing</b>	Automatic Call Distribution..... 17
	Caller ID..... 23
	Telemarketing Dial..... 61
	Walking Class of Service ..... 68
<b>Features just for attendants</b>	Alarm ..... 15
	Alternate Attendant ..... 16
	Monitor..... 41
	Night Answer ..... 42
	Removing Lines and Ext..... 50
	Forced Line Disconnect ..... 33
	Time and Date ..... 61
Call Forward System Cancel ..... 21	

## Basics

### Handsfree

Handsfree lets you place or answer calls without lifting the handset.

When you see the instruction, "Lift Handset," you can press HF instead.

- If MIC/DND lights when you press HF, your phone has Monitor, not Handsfree. You can listen to your call, but you must lift the handset to speak.
- If your phone has Automatic Handsfree, you can press a key without first pressing HF.
- If you are an attendant, you do not have Handsfree.

To talk Handsfree: 1. Speak toward phone.

To hang up a Handsfree call: 1. Press HF.

To change a handset call into a Handsfree call: 1. Press HF. Hang up.

To change a Handsfree call into a handset call: 1. Lift the handset.

### Outside Calls

You can place an outside call by dialing a code or by pressing a line key.

You can also answer an outside call using a line key. You may have line keys on your phone and on your DSS Console.

- ① **User-Programmable Feature:** You can change the lines that ring your phone. Refer to Ring Assignment and Delayed Ring Assignment in User-Programmable Features (page 76).

To place an outside call: 1. Lift handset.  
2. Press a line key.

*-The line key lights and you hear dial tone. You may also be able to press a line group (line rotary) key. These keys are also called outbound loop keys. Your communications manager can tell you which keys are line keys.*

3. Dial number.

*-If your system is behind a PBX or Centrex, you may have to dial 9 before your number. Check with your communications manager.*

**OR**

1. Lift handset.

2. Press ICM.

*-You hear dial tone.*

3. Dial line access code (e.g., 801).

*-You hear dial tone.*

*-You may also be able to dial a line group access code (9, or 90-98). If you have Direct Line Access, you can dial the outside line extension number (e.g., 372).*

*-If your system has ARS (Automatic Route Selection), 9 is normally your ARS access code.*

4. Dial number.

*-If your system is behind a PBX or Centrex, you may have to dial 9 before your number. Check with your communications manager.*

**To answer an outside call:**

1. A line key flashes and your phone rings.

*-The line key may be a line group (incoming line rotary) key. These keys are also called inbound loop keys.*

2. Lift handset.

- If you are not connected to the caller, press the flashing line key. The line key lights.
- To answer a call ringing the paging speakers, see the Night Answer feature.

## □ Intercom Calls

You can voice-announce your Intercom call or have the called extension ring. When you voice-announce, the other party hears you over the phone speaker and can speak Handsfree. Keep in mind that you may not be able to voice-announce to some extensions.

### To place an Intercom call: **Method 1**

(You can program this on a One-Touch Speed Dial key. See page 54.)

1. Lift handset.
2. Press ICM.
  - You hear dial tone.
3. Dial extension number or press DSS key.
  - You hear ringing. Wait for the party to answer.

#### **OR**

- You hear two beeps and can begin speaking.
- To force the phone to ring, dial 1 before you dial the extension number. You cannot force ringing if you use a DSS key.

### **Method 2**

1. Lift handset.
2. Press Hotline key.
  - You hear ringing. Wait for the party to answer.

#### **OR**

*-You hear two beeps and can begin speaking.*

*-You can also place an Intercom call by pressing a Station Call Coverage key. Refer to the Station Call Coverage feature.*

**To answer a ringing Intercom call:** (The ICM key flashes. If you are an attendant, the HF key flashes instead.)

1. Lift handset.

**To answer a voice-announced Intercom call:** (If you are an attendant, you cannot receive voice-announced calls.)

1. Listen for two beeps.  
*-ICM flashes.*
2. Speak toward phone.

 **User-Programmable Feature:** Use Voice Announce in User-Programmable Features to disable or enable voice-announced Intercom calls to your extension.

## Hold

 **This feature is always available.**

Hold lets you place a call in a temporary waiting state. While the call is on Hold, you can place and receive other calls. There are two types of Hold for outside calls: System Hold and Exclusive Hold. You can retrieve a call from System Hold at any extension. You can retrieve a call from Exclusive Hold only at the extension that placed it on Hold.

If you are an attendant, your phone has Automatic Hold. This means the system places your outside call on Hold automatically when you press:

- ICM or CONF
- A Line, Call Coverage, Hotline or Page key

- Things to remember about Hold:**
1. If a call remains on Hold too long, it recalls the extension that placed it on Hold. If unanswered, the call may ring other extensions.
  2. If a call is on a line that does not appear on your phone, you can only place the call on Exclusive Hold.
  3. If you place an Intercom call while you are on an outside call, you automatically place the outside call on System Hold. (If you have a DSS Console, press ICM or HOLD before pressing a DSS key.)

**To place your call on Hold:** (Do Not Hang Up.)

1. Press HOLD.
  - Press *HOLD* again to place an outside call on Exclusive Hold.
  - The line key flashes for an outside call.
  - The *HOLD* key flashes when the line does not appear on your phone and for an Intercom call.
2. Hang up.

**To retrieve an outside call from Hold:** **For a line that appears on your phone:**

1. Lift handset.
2. Press the flashing line key.

**OR**

**For a line you placed on Hold that does not appear on your phone:**

1. Lift handset.
2. Press HOLD.

**OR**

**For a line somebody else placed on System Hold that does not appear on your phone:**

1. Lift handset.
2. Press ICM.
3. Press \*.

4. Dial line access code (e.g., 801) or extension number.

### To retrieve an Intercom call

- from Hold:
1. At your extension: Lift handset.  
*-If you have Prime Line Selection, press ICM before going to the next step.*
  2. Press HOLD.  
*-You cannot put a Handsfree Intercom call on Hold.*

## Transfer

 **This feature is always available.**

You can Transfer an outside call to another extension. If the other party does not answer the transferred call, you can retrieve it. You cannot Transfer Intercom calls.

### To Transfer your call: (Do Not Hang Up.)

1. Press ICM and dial the extension number.  
*-You can press a DSS key instead of dialing the extension number. If you are an attendant, you can also press a DSS Console key.*

**OR**

1. Press Hotline key.  
*-To Transfer the call using a Station Call Coverage key, refer to the Station Call Coverage feature.*
2. Announce the call.  
*-If you hear ringing, wait for party to answer before announcing call. To Transfer the call unannounced, skip this step.*

*-If you hear busy tone, you can dial C to wait in line. Refer to the Camp-On feature on page 24. Also, your display shows, "HOLD/WAIT." This indicates the number of calls on Hold or already camped-on to the busy extension.*

3. Hang up.

**To retrieve the transferred call:**

1. Lift handset.
2. Press the flashing line key for the call.

***OR***

1. Retrieve call from Hold.

## Features

### Account Codes

For billing or other purposes, you can enter an Account Code (a number up to 10 digits long) to categorize your outside call. This Account Code is included in a report that the system generates. You can enter an Account Code manually as described below, or you can program a One-Touch Speed Dial key for Account Code entry (see page 54). This eliminates the need to place your call on Hold while you enter the number.

If your system has Mandatory Account Codes, you **must** enter an Account Code for each long distance call you place. If your Account Codes are also Verifiable, you **must** enter a code from a list programmed into your phone system. Ask your communications manager which type of Account Codes you have.

**To enter an Account Code when placing an outside call:** (You can program this on a One-Touch Speed Dial key. See page 54.)

1. Place call.
2. Press PGM# immediately after dialing the number.
3. Enter Account Code.
4. Press PGM#.

**To enter an Account Code for the call you are on:** (You can program this on a One-Touch Speed Dial key. See page 54.)

1. Do not hang up.
2. Press ICM.
3. Press PGM#.
4. Enter Account Code.
5. Press PGM#.
6. Press HOLD.

*-You are reconnected to your call.*

## ☐ Alarm

☞ **This feature is for attendants only.**

Your telephone display may show an alarm message. Alarm messages occur when a telephone is unplugged or fails, when a line fails or when a printed circuit card in the system equipment fails. Telephone and line failures display as Minor Alarms. Printed circuit card failures display as Major Alarms. Your display also shows you which extension or card failed. Report alarms to your communications manager.

When an alarm displays, your phone does not ring normally for incoming calls. If your phone has Off-Hook Ringing, it rings with a single beep (repeated). If your phone does not have Off-Hook Ringing, calls do not ring while the alarm displays. Your communications manager can tell you if you have Off-Hook Ringing.

**To see the cause of an Alarm:** (Do not lift the handset.)

1. Press MSG.  
*-Display shows cause of Alarm. For example: "STA 305 FAILED" or "LINE 02 FAILED."*
2. Press MSG to see if there is more than one failure.  
*-When you see the first failure message again, you have gone through the entire list.*
3. Lift and replace handset to clear the alarm display.

### Alternate Attendant

 **This feature is for attendants only.**

Alternate Attendant allows you to reroute your incoming calls to another extension (your Alternate Attendant). You may want to reroute calls when you are busy or you must leave your phone. Outside calls ring at both your extension and the Alternate Attendant. The MIC/DND and MSG keys flash slowly while the Alternate Attendant is assigned.

When you assign the Alternate Attendant, you cancel your Selectable Display Message (if any). The Alternate Attendant must be a keyset. You cannot assign another attendant as your Alternate Attendant.

**To assign the Alternate Attendant:** (You can program this on a One-Touch Speed Dial key. See page 54.)

1. Lift handset.
2. Press ICM.
3. Press PGM#.
4. Dial Alternate Attendant's extension number.
5. Dial 3.  
*-Your display shows, "ALT OPR ASSIGNED."*
6. Hang up.

**To cancel the Alternate Attendant assignment:**

1. Press MIC/DND.  
*-Your display shows, "CANCEL ALT OPR." To return to the Time and Date display, lift and replace the handset.*

## □ Automatic Call Distribution

### ACD Member (Agent)

Your extension may be in an Automatic Call Distribution group. The members of your ACD group share responsibility for answering the group's calls. ACD evenly distributes the calls among the group members. Normally, the member (agent) that has been idle the longest gets the next call.

From time to time, you may need to temporarily remove yourself from the group (for example, when you go to lunch). When you become Off Duty, ACD no longer sends calls to your extension. When you become On Duty, you'll again start to receive ACD calls.

- To become On or Off Duty:**
1. Lift handset.
  2. Press ICM.
  3. Dial 6 to go Off Duty; dial 4 to go On Duty.
  4. Dial PGM#.

### ACD Supervisor

You may be an ACD supervisor. If you are, you should have a display keyset. You should also have a DSS Console with a Hotline key for each group member and your ACD group master number. As a supervisor, you can:

- Monitor the status of your group on your DSS Console. You can be the supervisor of more than one ACD group.
- Be notified when all agents are busy, and how long calls have been waiting for an available agent. Your telephone display shows this information.
- Make agents On or Off Duty.
- (Optional) Record the announcements that your group's callers hear. Your communications manager can tell you if you need to record any announcements. To record announcements, your system must have a VMU Module.

**To monitor the status of your ACD group:** Watch your DSS Console.

*-If Agent's key is      Agent is  
OFF. . . . . Idle  
ON. . . . . Busy  
Flashing Slow . . . . Off Duty  
Flashing Fast. . . . In DND*

**AND**

1. On your DSS Console, press the Hotline key for your ACD group master number.
2. Watch your telephone display.  
*-Your display shows information for the group selected in the previous step. For example, if your display shows, "02 L-04 00:47," you have two calls waiting (02). The call on line 4 (L-04) has been waiting longest: 47 seconds (00:47).*

**To make agents on and off duty (supervisors only):**

1. Lift handset.
2. Press ICM, then PGM#.
3. Press DSS key for agent you'll change.
4. Dial 7 to remove agent; 4 to install.

**To record announcements for your ACD callers:**

1. Lift handset
2. Press ICM, then PGM#.
3. Dial MV (Master Voice Message).
4. Enter the number of the message you want to record (00, 02-07).  
*-Your communications manager can tell you which message to record. Message 00 is the standard ACD All Agents Busy message.  
-The system prompts, "Please start recording."*
5. After you hear the beep, speak clearly and directly into the handset.  
*-The announcement can be up to 16 seconds.*

6. Hang up when through recording.

**To listen to a previously recorded announcement:**

1. Lift handset
2. Press ICM.
3. Press PGM#.
4. Dial MVL (Message Voice Listen).
5. Dial the message number (00,02-07).

**To erase all your recorded announcements (including OPA announcements):**

1. Lift handset.
2. Press ICM.
3. Press PGM#.
4. Dial MV and press PGM#.  
*-Your display shows, "DELETE ALL MSG?"*
5. To erase messages, dial Y.  
*- Your display shows, "COMPLETED."*  
**OR**  
To quit without erasing, dial N.  
*- Your display shows, "ABORTED."*
6. Hang up.

## Background Music

You can receive Background Music over your telephone's speaker. The music stops whenever a call comes in or you lift the handset. You can turn the music on or off only when your telephone is not in use. To have Background Music, your system must have an optional music source connected.

The volume setting for Background Music also sets incoming ringing and paged announcement levels over the telephone's speaker.

**To turn Background Music on or off:** (Do not lift handset.)  
1. Press HOLD.

- To adjust the volume of Background Music:**
1. Press VOL UP or VOL DN while feature is active or telephone is idle.

### Call Forwarding

With Call Forwarding, you can reroute your incoming calls to another extension or to an outside number. If you are an attendant, you cannot use Call Forwarding. Use Alternate Attendant instead (see page 16).

- To forward calls:** (This may be programmed on a One-Touch Speed Dial key. See page 54.)
1. Press ICM.
  2. Press PGM#.
  3. Dial extension number to receive calls.
  4. Do one of the following:
    - Dial 1 to forward calls not answered.
    - Dial 2 to forward calls not answered or when busy.
    - Dial 3 to forward all calls.
    - Dial 4 to have Voice Mail screen your calls (i.e., emulate a personal answering machine). Turn to page 62 for more on this option.
  5. Press HF to hang up.
    - MSG flashes slowly. A voice prompt may remind you that your calls are forwarded.

- To cancel Call Forwarding:**
1. Press ICM.
  2. Press PGM#.
  3. Press HF to hang up.
    - MSG goes out.

## Off-Premise Call Forwarding

You can reroute your calls to an outside (off-premise) telephone number. For example, you can forward your calls to your cellular car phone if you have to be on the road.

- To forward calls to an outside number:**
1. Press ICM
  2. Press PGM#.
  3. Dial 1.
  4. Dial line number (e.g., 01).  
-You may also be able to dial a line group code (9, 90-98).
  5. Dial telephone number that is to receive calls.
  6. Press HF to hang up.

## Call Forward System Cancel

 **This feature is for attendants only.**

Call Forwarding reroutes incoming calls to another extension, or to an outside number. As the attendant, you cannot use Call Forwarding (see the Alternate Attendant feature on page 16 instead). You can, however, cancel all Call Forwarding for the system (including Selectable Display Messages). This also cancels Do Not Disturb for the system.

- To cancel all Call Forwarding:**
1. Lift handset.
  2. Press ICM.
  3. Press PGM#.
  4. Press \*.
  5. Hang up.

## Call Timer

With Call Timer, you can use your phone's display to time your outside calls. You can time either incoming or outgoing calls.

- To start the Call Timer (if you have a Timer key):**
1. Press Timer key.  
*-The Timer key is ON. Your display starts timing your call. Press the Timer key before you place or answer your call — or while idle. If your phone has Auto Timer, it starts automatically for outside calls. You don't have to press the Timer key.*

- To stop the Call Timer (if you have a Timer key):**
1. Press Timer key.  
*-The Timer key is OFF. You can stop the timer before or after you hang up. To restart the timer from 00:00, press the Timer key again.*

## Callback

When you call a busy extension, you may leave a Callback request for a return call. You do not have to repeatedly call the busy extension back, hoping to find it idle. You will note that the Callback ring cadence is longer than other ringing signals. If you are an attendant, you cannot use Callback. To leave a Callback for an outside line, see the Line Callback feature on page 38.

- To request a Callback (after calling a busy extension):** (Do not hang up.)
1. Dial C.  
*-You hear ringing.*
  2. Hang up.  
*-You can use your phone for other calls while you wait for Callback to ring you back.*

- To answer when Callback rings you back:**
1. Lift handset.  
*-If you hear ringing, wait for party to answer.*

**OR**

*-If you hear two beeps, go ahead and speak.*

- To cancel a Callback request to a specific extension:**
1. Call busy extension again.  
*-You hear busy tone.*
  2. Press \*.
  3. Hang up.

- To cancel all your Callbacks simultaneously:** (This also cancels your Line Callbacks.)
1. Lift handset.
  2. Press ICM.
  3. Press \*.
  4. Press FTR.
  5. Hang up.

## Caller ID

If your phone has a display, Caller ID can show your incoming caller's number and optional name. The Caller ID information will show as either a *post-answer* or *pre-answer* display. With the post-answer display, you'll see the caller's number and optional name *after* you answer the call. The pre-answer display lets you see the caller's number and optional name *before* you answer the call. You can also use the pre-answer display to preview incoming calls before you answer them. The Caller ID pre-answer display is available only if your telephone does not have Automatic Handsfree (see page 7). Check with your communications manager.

- To answer a Caller ID call (with the pre-answer display disabled):**
1. Lift handset or press flashing line key.  
*-You see the incoming caller's name and number and you answer the call.*

- To answer a Caller ID call (with the pre-answer display enabled):** (Your phone must have Automatic Handsfree disabled to use this feature.)
1. Press the flashing line key to display the incoming caller's phone number.

- You can press another flashing line key instead of going to the next step.
- 2. Press the flashing line key again to display the incoming caller's name.
  - If the telephone company does not offer the name option, you skip to the next step.
  - You can press another flashing line key instead of going to the next step.
- 3. Lift the handset to answer the call.
  - If you previewed several ringing lines, you'll answer the call on the most recently pressed line key.

**To re-display the Caller ID information for the call you are on:**

1. Press the line key for the call.

Under certain conditions, you may see one of the following messages in place of the normal Caller ID information.

<b>When you see . . .</b>	<b>It means . . .</b>
PRIVATE	Your caller has blocked Caller ID.
OUT OF AREA	You caller has dialed from an area that does not support Caller ID
UNAVAILABLE	Your telephone company's Caller ID service is out of order

**Camp-On**

Camp-On allows you to call a busy extension or line and wait off-hook until that extension or line becomes free.

**To Camp-On to a busy extension or line:** (Do Not Hang Up.)  
1. Dial C.

*-If you Camp-On to a busy extension...  
You hear ringing in your handset. When the party is free, their phone rings.*

**OR**

*-You hear two beeps and you can begin speaking.*

*-If you Camp-On to a busy line...  
Busy tone stops. When you hear dial tone, dial your outside call.*

**To answer a Camp-On:** (You hear two beeps while you are on a call.)  
(Do not hang up.)

1. Press ICM.

*-Your first call goes on Hold. You connect to the calling party.*

**To return to the first call and switch (split) between calls:**

1. Press ICM.

2. Press \* and dial S (dial pad key 7).

## Conference

 **This feature is always available.**

Conference allows you to converse jointly with two inside parties, two outside parties or one of each.

**To set up a Conference:**

1. Place first call.
2. Press CONF.
3. Place next call.
4. Press CONF.

*-The CONF key lights and the three parties are Conferenced.*

- To cancel a Conference:
1. Hang up.  
*-If your Conference included an Intercom call, your callers continue to converse after you hang up.*

**OR**

1. Place Conference on Hold.
2. Disconnect one of your callers.
3. Hang up on your remaining caller.

### Conference, Unsupervised

Use Unsupervised Conference when you want to join two outside callers in a Conference — then leave the Conference and allow them to talk privately. Once you set up this type of Conference, it continues until one of the outside callers hangs up. You cannot rejoin the Conference or terminate it from your phone.

- To set up an Unsupervised Conference:
1. Place or answer first outside call.  
*-You talk to the first caller.*
  2. Press CONF.
  3. Place or answer second outside call.  
*-You talk to the second caller.*
  4. Press CONF again.  
*-You talk to both callers.*
  5. Hang up.  
*-Your callers talk privately with each other. You cannot rejoin the Conference.*

### Dialing Number Preview

Dialing Number Preview (DNP) allows you to dial, review, and correct a number before the system dials it out for you. You can only use Dialing Number Preview if you have a display telephone.

- To dial using DNP:
1. Lift handset  
*-This is optional unless you are an attendant.*

2. Press \*.  
-Your display shows, "DIAL PREVIEW."
3. Dial number.  
-Your display shows digits dialed, with a cursor (-) after the last digit.

- To correct digits:**
1. Press DN to move the cursor left to the incorrect digit. Press UP to move the cursor to the right, one digit at a time.
  2. Dial correct digit.  
-Your display shows the new digit and the cursor moves one space to the right.
  3. Press FTR to move the cursor to the end of the digits.  
-The system dials only the digits up to the cursor.
  4. Press DIAL.  
-The system automatically selects a line and dials the number.

**OR**

-Your display shows, "SELECT IDLE LINE," and you must press a line key. The system then dials the number.

- To exit DNP at any time:**
1. Press HF.

**Direct Station Selection**

Direct Station Selection keys (the third-level function of programmable keys 1-15) provide easy access to other extensions. They also act as busy lamps, indicating the status of an associated extension.

When the key is...	The extension is...
OFF	Idle
ON	Busy

When the key is...	The extension is...
Flashing	DND

- ① **User-Programmable Feature:** Also refer to DSS in User-Programmable Features (page 76). When programming DSS keys, you can use the User-Programmable Feature or the procedure below. If a DSS key is also a Station Call Coverage key, changing DSS also changes the Call Coverage assignment.

- To program your DSS keys:**
1. Lift handset.
  2. Press ICM, then PGM#.
  3. Press the desired DSS key.
  4. Dial the extension number you want assigned to the key.
    - To clear a DSS key, press \*.
    - Program additional keys by repeating the last three steps. All unprogrammed keys call extension 300.
  5. Hang up.

- To call an extension using a DSS key:**
1. Lift handset.
  2. Press ICM.
    - The key lights show you the status of the assigned extensions.
  3. Press the DSS key for the desired extension.

## Directed Call Pickup

Directed Call Pickup allows you to answer a call ringing another extension. You may also have Call Coverage keys on your phone. You can use these keys instead of Directed Call Pickup to answer a call to the covered extension. Refer to the Station Call Coverage feature on page 59.

- To Pickup a call ringing at another phone:** (You can program this on a One-Touch Speed Dial key. See page 54.)
1. Lift handset.
  2. Press ICM.
  3. Press \*.
  4. Dial ringing extension number.
    - You are connected to the caller.*
    - This procedure also picks up a call on System Hold or Parked at the extension you dial. Refer to the Hold (page 10) and Park (page 47) features.*

## Directory Dialing

Directory Dialing lets you call a Speed Dial or Intercom number by selecting the name associated with the number. There are three types of directories:

- Intercom (dials extension numbers)
- Personal (dials your Personal Speed Dial numbers)
- Company-wide (dials the first 100 System Speed Dial numbers)

- To dial a number using Directory Dialing:**
1. Lift handset (attendant only).
  2. Select type of directory.

*-For Intercom Directory, dial I. Your display shows, "INTERCOM DIRECTORY."*

**OR**

*For Personal Directory, dial P. Your display shows, "PERSONAL DIR."*

**OR**

*For Company-wide Directory, dial C. Your display shows, "COMPANY WIDE DIR."*

*-If your display shows, "NO RAM INSTALLED" when you press P or C, you can only use Intercom Directory Dialing.*

3. Dial the first letter of the desired name.  
*-To enter a Q or a Z, press 0 (zero).*
4. Dial the digit (1, 2 or 3) that identifies the desired letter.  
*-The display shows the first name beginning with that letter. If there are none, the display shows: X-UNLISTED NAME (X is the letter you entered).*
5. Press UP or DN to scroll through the names beginning with this letter. Stop at the desired name.  
*-To begin with the first name in the list (so you can scroll through all the names), press PGM#.*
6. Press DIAL.  
*-The system dials the number stored with that name.*  
*-If you are transferring, pressing DIAL initiates a screened transfer. For an unscreened Transfer, hang up instead.*

**To cancel Directory Dialing at any time:**

1. Hang up.

## Display Messages

Messages appear in the display window to provide helpful information at a glance. When your phone is not in use, the date and time display. When you use your phone, messages display to explain what is happening or to help you remember what to do next. If you have a question about the displays, check with your communications manager.

**To adjust the brightness of your telephone display:**

1. Press VOL UP or VOL DN while your phone is idle.

*-Your phone must be idle (not ringing),  
with Background Music off.*

## Do Not Disturb

Do Not Disturb (DND) blocks Page or ringing at your extension. If you call an extension that is in DND, you hear a reorder tone. You may be able to override DND. If you are an attendant, you cannot place your phone in DND.

**To put your phone in Do Not Disturb:** 1. Press MIC/DND until it flashes.

**To cancel Do Not Disturb:** 1. Press MIC/DND until it goes out.

**To Override your Hotline partner's DND:** (The Hotline key for your partner flashes on your phone.)

1. Lift handset.
2. Press Hotline key twice.  
*-The phone rings if idle; wait for an answer.*

**OR**

1. Place Intercom call to extension in DND.
2. Dial I.  
*-The phone rings if idle; wait for an answer.*

## Door Box

Your system may have Door Boxes. A Door Box is a self-contained Intercom unit typically used to monitor entrance doors. A visitor at the door can press the Door Box call button (like a door bell). The Door Box then sends chimes to certain extensions. If you receive Door Box chimes, you can just lift the handset to answer them. You can then talk to the visitor at the door.

## Flash

---

Door Boxes come in handy at delivery entrances. Your company doesn't need to have someone at the door to monitor the entrance. You can just answer the Door Box instead. If the door has an electric strike connected to a Relay Box, you can use your phone to release the door.

- To answer the Door Box chimes:**
1. Lift handset.  
*-If you have a Call Coverage or Hotline key for the Door Box, you can press it instead.*

- To call the Door Box:**
1. Lift handset.
  2. Press ICM.  
*-If you have a Call Coverage or Hotline key for the Door Box, you can press it instead.*
  3. Dial Door Box extension number.  
*-Your system can only have Door Boxes at extensions 310, 311, 322 and 323.*
  4. (Optional) Press and hold FTR to release the door.  
*-You can have Relay Boxes for the Door Boxes at extensions 311, 322 and 323 only.*

## Flash

While you are on an outside (CO) call, Flash allows you to regain dial tone without giving up control of the line. You can then place another call. Flash also allows access to PBX features when using a PBX line.

- To flash the line you are on:** (Do Not Hang Up.)
1. Press FTR.
  2. Dial number.

## ☐ **Forced Line Disconnect**

☞ **This feature is for attendants only.**

Forced Line Disconnect allows you to disconnect a call on an outside line. This may be necessary, for example, when a call is terminated but the line remains locked up (line key stays lit).

- To disconnect a line:**
1. Lift handset.
  2. Press desired line key.
  3. Press PGM#.
  4. Hang up.

**OR**

1. Lift handset.
2. Press ICM.
3. Dial line access code (e.g., 801).
4. Press PGM#.
5. Hang up.

## ☐ **Group Call Pickup**

Your extension may be in a group with some of your co-workers' extensions so you can easily pick up each other's calls. You can answer a call that is ringing any extension in the group by dialing a Group Call Pickup access code. You may have Group Call Pickup keys on your phone, which you can also use to answer calls. You don't have to be a group member to have Group Call Pickup keys.

**To answer a call ringing in a Pickup Group from a phone within that Pickup Group:** (You can program this on a One-Touch Speed Dial key. See page 54.)

1. Lift handset.
2. Press ICM.
3. Press \* and dial 1.

*-You are connected to the caller. Your display shows, "P (+ name)" or "PICKUP FROM (+ extension number)."*

**OR**

1. Lift handset.
2. Press the flashing Group Call Pickup key.
  - The key flashes when a call is ringing the group.
  - You are connected to the caller. Your display shows, "P (+ name)" or "PICKUP FROM (+ extension number)."

- ① **User-Programmable Feature:** Use Ring Assignment/Delayed Ring Assignment in User-Programmable Features (page 76) to assign Pickup Group key ringing.

### Group Listen

Group Listen lets you talk into your handset and have your caller's voice broadcast through your telephone speaker. With Group Listen, others in your work area can listen to your conversation. If you are an attendant, you cannot use Group Listen.

- To initiate Group Listen:**
1. Establish handset call.
  2. Press HF (but do not hang up).
    - HF lights.

- To cancel Group Listen:** (Do not hang up.)
1. Press HF.
    - HF goes out.

### Group Ring

During installation, certain extensions in your system were arranged into Ring Groups. When you call a Ring Group number, all extensions in the Ring Group ring. You can also answer a Ring Group call.

- To place a call to a Ring Group:** (You can program this on a One-Touch Speed Dial key. See page 54.)

1. Lift handset and press ICM.
2. Dial Ring Group number (e.g., 396).  
-*You hear ringing; wait for an answer.*

**To answer a Ring Group call at any phone:** (You can program this on a One-Touch Speed Dial key. See page 54.)

1. Lift handset and press \*.
2. Dial Ring Group number (e.g., 396).  
-*You are connected to the caller.*

**To answer a Ring Group call ringing your group:**

1. Lift handset.  
-*The ICM key or a Line key lights.*

## Headset

If you have a Headset, you can use it instead of the handset. Using the headset frees up your hands for other work.

- To install the headset:**
1. Leave the handset in the cradle.
  2. Unplug the handset and plug in the headset.

### **For Non-attendant Keysets**

Use the HF key to hang up calls in place of the handset.

- To operate a Headset:**
1. Press HF whenever you see the instruction, "Lift handset."
  2. Press HF whenever you see the instruction, "Hang up."

### **For Attendants**

- To answer a call using the headset:**
1. Press RLS on the DSS Console.  
-*If you have Ringing Line Preference (page 51), this answers the call.*
  2. Press the flashing line or Intercom loop key.

- To place a call using the headset:
1. Press RLS on the DSS Console.
  2. Press the flashing line or Intercom loop key.

*-If you have Ringing Line Preference, press the line or Intercom loop key before pressing RLS.*

- ① **User-Programmable Feature:** You can allow or deny Headset operation for your phone. Refer to Headset in User-Programmable Features.

## Hotline

Hotline gives you one-button calling and Transfer to another extension (your Hotline partner). The Hotline key on your phone shows the status of your partner's extension.

When the Hotline key is ...	Your partner is ...
OFF	Idle
ON	Busy
Flashing	DND

You may be able to override an extension in Do Not Disturb using your Hotline key. Refer to the Do Not Disturb feature on page 31.

- ① **User-Programmable Feature:** You can use Hotline in User- Programmable Features (page 76) to change your Hotline assignment.

- To place a call using a Hotline key:
1. Lift handset.
  2. Press the Hotline key.
- If the Hotline key to your partner is lit, see the Off-Hook Signaling feature on page 43.*

- To transfer the call you are on using a Hotline key:** (Do Not Hang Up.)
1. Press the Hotline key.  
*-If your partner doesn't answer, you can press another Hotline key instead of going to step 2.*
  2. Hang up, or wait for an answer.

- To answer a call from your Hotline partner:** (ICM flashes.)
- If you are not an attendant...
1. Listen for two beeps.
  2. Speak toward the phone.
- If you are an attendant...
1. Lift handset.
  2. Press HF (Intercom loop key).

### Intrusion (Barge-In)

Intrusion allows you to break into another conversation.

**CAUTION:** Unauthorized intrusion on calls using this feature may be interpreted as an invasion of privacy.

- To intrude on a busy extension:** (Do Not Hang Up.)
1. Dial I (dial pad key 4).  
*-Busy party hears two short beeps.*  
*-You cannot Intrude on a Conference call.*  
*-If you hear fast busy tone, you cannot Intrude.*
  2. Wait about four seconds, until the CONF key lights.  
*-You and the other two parties are in Conference.*

### Last Number Redial

 **This feature is always available.**

With Last Number Redial, you can easily call the last outside number you dialed. Each time you place an outside call, the system saves the number you dialed (up to 24 digits). You can redial the call whether it was answered, unanswered or busy. Redial uses the same line to dial out unless you select a different line.

- To place a call using Last Number Redial:**
1. Lift handset.  
*-To select a different line, press a line key*
  2. Press DIAL.
  3. Press LAST.  
*-If you hear busy tone, press an idle line key. Your call dials out automatically.*

### Line Callback

You can leave a Callback request for a busy outside line. The system rings you when the outside line is available. You do not need to keep checking the line, hoping to find it idle. You will note that the Callback ring cadence is longer than other ringing signals. To leave a Callback for an extension, see the Callback feature on page 22. If you are an attendant, you cannot use the Line Callback feature.

- To request a Callback for an outside line on a line key:**
1. Press illuminated line key.  
*-You hear busy tone.*
  2. Dial C.  
*-Busy tone stops.*
  3. Hang up.  
*-Use your phone for other calls while you wait for Callback to ring you back.*

- To request a Callback after dialing a code for an outside line:**
1. Dial C and hang up.

*-You can use your phone for other calls while you wait for Callback to ring you back.*

- To answer when Callback rings you back:**
1. Lift handset.  
*-You hear dial tone on the line you requested.*
  2. Place call.

- To cancel a Callback request to a specific line:**
1. Try to access busy line again.  
*-You hear busy tone.*
  2. Press \* and hang up.

- To cancel all your Callbacks simultaneously:** (This also cancels your Intercom Callbacks.)
1. Lift handset.
  2. Press ICM and dial \*.
  3. Press FTR.
  4. Hang up.

## **Meet-Me Conference**

Meet-Me Conference allows you to set up a Conference with up to two other inside parties. Each party joins the Conference by dialing a Meet-Me Conference access code. Also see Conference on page 25.

- To set up a Meet-Me Conference:**
1. Page desired parties and announce Meet-Me Conference code (11 or 12).
  2. Press ICM.
  3. Dial Meet-Me Conference access code.

- To join a Meet-Me Conference:**
1. Lift handset and press ICM.
  2. Dial announced Meet-Me Conference access code (11 or 12).  
*-The CONF key lights when the three parties join the Meet-Me Conference.*

### Message Waiting

You can leave a Message Waiting indication at a busy or unanswered extension requesting a return call. The indication is a flashing MSG key and an optional voice reminder message. If you are an attendant, another extension user cannot leave a Message Waiting at your extension. Also see Voice Mail on page 62.

**To leave a Message Waiting** (Do Not Hang Up.)

**after calling an extension:**

1. Press MSG.

*-You hear dial tone. You cannot leave a Message Waiting while using Whisper Page. See Off-Hook Signaling on page 43.*

2. Hang up.

**To answer a Message** (Your MSG key flashes fast.)

**Waiting left at your extension:**

1. Lift handset and press MSG.

*-The system calls the extension that left you the message. Your MSG key continues to flash if you have additional Messages Waiting.*

**To select the message you** (Do not lift handset.)

**want to answer (from your display phone):**

1. Press MSG.

*-Your display shows the extension which left you the message. Press MSG again until you see the message you want to answer.*

2. Lift handset.

3. Press MSG.

*-The system calls the extension you selected.*

**To cancel all the messages** (This also cancels your Intercom and Line  
**left on your phone:** Callbacks.)

*-You cannot cancel a Message Waiting you left at an individual extension.*

1. Press ICM.
2. Press PGM#.
3. Press \*.
4. Press HF to hang up.

## **Microphone Mute**

Microphone Mute allows you to turn off your phone's Handsfree microphone at any time. When you activate Microphone Mute, you can still listen to your caller but your caller cannot hear your voice. If you are an attendant, you cannot use Microphone Mute.

- To activate Microphone Mute:**
1. Press MIC/DND until it lights.
- You can do this while on a call or when your phone is idle (to turn off Handsfree reply to a voice-announced call).*

- To deactivate Microphone Mute:**
1. Press MIC/DND until it goes out.
- If MIC/DND flashes fast, your phone is in Do Not Disturb instead on page 31.*

## **Monitor**

 **This feature is for attendants only.**

Monitor allows you to listen to somebody else's phone conversation, without them hearing you or knowing you are on the line. When you monitor someone on an outside call, you hear both parties. However, when you monitor someone on an inside call, you only hear their caller. You cannot Monitor a Conference call.

**CAUTION:** Unauthorized monitoring of calls using this feature may be interpreted as an invasion of privacy.

- To monitor a call:**
1. Lift handset and press ICM.

2. Dial the extension number.
3. Dial M.  
*-You hear the conversation.*

### Night Answer

 **This feature is for attendants only.**

If you are an attendant, you can place the system in Night Answer. While in Night Answer, the system reroutes incoming calls to preselected extensions or through the paging system. The MIC/DND key flashes only at your extension while the system is in Night Answer.

**To place the system in Night Answer (attendants only):**

1. Press MIC/DND.  
*-The MIC/DND key flashes. Your display shows, "NIGHT MODE ON."*

**To take the system out of Night Answer (attendants only):**

1. Press MIC/DND.  
*-The MIC/DND key goes out. Your display shows, "NIGHT MODE OFF."*

**① User-Programmable Feature:** You can change the lines that ring your phone at night. Refer to Night Ring in User-Programmable Features (see page 76).

**To answer a call during Night Answer:** (You can program this on a One-Touch Speed Dial key. See page 54.)

1. Lift handset.
2. Press ICM.
3. Press \*.
4. Dial 0.  
*-You are connected to the caller.*

**OR**

1. Lift handset.
2. Press flashing line key.

## □ Off-Hook Signaling

While on a call, Off-Hook Signaling alerts you when you have another call waiting to be answered. The off-hook signal is a tone through the speaker when the call is ringing in. You can answer the waiting call.

Off-Hook Signaling also allows you to signal a busy extension when you want to talk to them. If the busy party is on a handset call, they hear your voice in their handset (called Whisper Page) or beeps over the speaker. The party can select to talk to you or their initial caller. If the busy party is on a Handsfree call, they hear a beep. You cannot use Whisper Page if you are an attendant.

- ① **User-Programmable Feature:** You can allow or deny Whisper Page for your extension. Refer to Whisper Page in User-Programmable Features (page 76).

### Whisper Page

**To respond to a Whisper Page signal:** (You hear two beeps before your caller's voice.)

1. Press and hold MIC/DND.  
*-To talk to the first party, release MIC/DND.*

### Off-Hook Signaling

**To respond to an Off-Hook Signal (one beep over your speaker):** (Do Not Hang Up.)

1. (Optional) Press HOLD to save your first call.  
*-If you are an attendant, your phone saves outside calls automatically. You can skip this step.*
2. Press the flashing ICM or line key.

**To signal an off-hook extension:**

1. Lift handset.
2. Use DSS or Hotline.

*-If the called party is busy on a handset call and you press a DSS or Hotline key, Off-Hook Signaling is automatic. If the called party is busy on a Handsfree call and you press a DSS or Hotline key, Camp-On is automatic. See page 24 for more on Camp-On.*

**OR**

1. Lift handset.
2. Press ICM.
3. Dial extension number.
4. When you hear ring-busy, dial 1.

*-If you hear several beep tones, go ahead and speak. If you hear ringing instead, wait for called party to answer.*

## Operator Assistance

Operator Assistance (OPA) automatically answers outside calls and provides dialing options to the outside callers. OPA lets an outside caller dial an extension or hunt group directly. You or a co-worker do not have to screen the call.

When OPA answers a call, the caller hears a recording of their dialing options. For example, the announcement could say, "Hello. You have reached XYZ Corporation. Dial 4 for Technical Service or 5 for Sales." You may be able to record the messages callers hear. Before recording, check with your communications manager to find out about the OPA messages. To use Operator Assistance, your system must have a VMU Module.

- To record an OPA message:
1. Lift handset.
  2. Press ICM.
  3. Press PGM#.
  4. Dial MV.
  5. Dial the OPA message number (02-07) you want to record.

*-Your communications manager can tell you about each message.*

6. Wait for instructions, then begin recording.
7. Hang up.

**To listen to a previously recorded OPA message:**

1. Lift handset.
2. Press ICM.
3. Press PGM#.
4. Dial MVL.
5. Dial the message number (02-07) you want to hear.

*-Your communications manager can tell you about the messages.*

6. Hang up.

**To erase all OPA messages (including the ACD overflow message):**

1. Lift handset.
2. Press ICM.
3. Press PGM#.
4. Dial MV.
5. Press PGM#.
6. Dial Y.

*-To exit the procedure without erasing the messages, dial N.*

7. Hang up.

**To call into the system using Operator Assistance:**

1. Dial system telephone number.
2. After OPA answers, dial announced option:  
Dial single-digit option  
OR  
Dial 3 plus the extension you wish to reach.

## Page, Zone

You can make an announcement (Page) to other extensions and external speakers.

Your system can have up to seven Internal Paging Zones and an All Call Paging Zone. When you Page an Internal Zone, only those telephones in the zone receive the announcement. When you make an All Call Page, all phones receive the announcement.

Additionally, your system may have External Paging Zones. If you page to an internal zone, the announcement broadcasts over the corresponding external zone as well. Your system can have up to two external zones (zones 1 and 2). All Call Paging is broadcast to both External Paging Zones (speakers). Your communications manager can tell you if your system has this capability.

- ① **User-Programmable Feature:** You can allow or deny Pages to your phone. Refer to Page in User-Programmable Features on page 76.

**To make an All Call Page or a Zone Page:** (You can program this on a One-Touch Speed Dial key. See page 54.)

1. Lift handset.
2. Press ICM.
3. Dial Page Zone access code, as follows:

Page Zone	Access Code
All Call	1 *
1	2 *
2	3 *
3	4 *
4	5 *
5	6 *
6	7 *
7	8 *

*-You hear two beeps.*

*-If your system has a PCU Module, you may have codes for additional External Page Zones. Check with your communications manager.*

4. Make announcement.
5. Hang up.

**OR**

1. Lift handset.
2. Press Page key.
  - You hear two beeps. If the zone is busy, you hear fast busy tone instead.*
  - You may have Page Zone keys on your phone and your DSS Console. The key is lit when the zone is busy.*
3. Make announcement.
4. Hang up.

## **Park**

When you must transfer an outside call to someone you cannot readily locate, use Park. Park puts the call in a special holding state (called an Orbit) so you can page the person. The person you page can then pick up the call from any extension.

There are two types of Park Orbits: System Park and Personal Park. With System Park, you may Park a call in one of ten system orbits (60-69). With Personal Park, you can Park a call at an extension. In either case, the call recalls to you if not picked up.

**To Park the call you are on:** (Do Not Hang Up.)

1. Press ICM.
2. Dial Park Orbit access code. To use System Park, dial 60-69.
  - To use Personal Park, dial \* and the extension number.*
  - You hear dial tone. If you hear busy tone, press ICM and dial another orbit.*

3. Page party to receive call and announce the Park Orbit access code.
4. Hang up.

**OR**

1. Press the Park Orbit key.  
*-You hear dial tone. The key flashes for calls you parked and is on for calls co-workers have parked.*
2. Page party to receive call.
3. Hang up.

**To pick up a Parked call:** (You can program this on a One-Touch Speed Dial key. See page 54.)

1. Lift handset.
2. Press ICM.
3. Dial Park Orbit access code.  
*-To use System Park, dial 60-69. To use Personal Park, dial \* and the extension number. You are connected to the party. Your display shows, "CALL FROM ORBIT."*

**OR**

1. Lift handset.
2. Press Park Orbit key.  
*-You are connected to the party. Your display shows, "CALL FROM ORBIT." You may have Park Orbit keys on your phone and on your DSS Console.*

## Personal Greeting

You can record a Personal Greeting (i.e., brief message) for your extension. When you leave your extension unattended, callers hear your Personal Greeting. After the caller listens to your message, you can optionally have the call forwarded to another extension. If you are an attendant, you cannot use Personal Greeting. Personal Greeting requires a VMU Module.

- To record a Personal Greeting:**
1. Lift handset.
  2. Press ICM.
  3. Press PGM#.
  4. Dial M V.  
*-Dial A for all calls.*  
*-Dial I for internal calls only.*
  5. The system prompts, "Please start recording."
  6. After you hear the beep, speak clearly and directly into the handset.
  7. (Optional) Enter three-digit extension where calls will be transferred. Intercom dial tone will be heard.
  8. Hang up when you are through.  
*-The Message Waiting key flashes slowly.*

- To cancel your Greeting:**
1. Lift handset.
  2. Press ICM.
  3. Press PGM#.
  4. Hang up.

## Prime Line Selection

With Prime Line Selection, you automatically connect to an outside line when you lift the handset. You can use your Prime Line for placing or answering calls. Prime Line Selection simplifies handling calls on your most frequently-used line. Check with your communications manager to see if you have a Prime Line.

- ① **User-Programmable Feature:** You may be able to assign Prime Lines from your phone. Refer to Prime Line in User-Programmable Features on page 76.

### Privacy Groups

If your extension is in a Privacy Group, you can enter another group member's outside call unannounced and uninvited. Each member of the group can select Privacy. This prevents members from entering the call.

- To join a conversation with a member of your Privacy Group:**
1. Lift handset.
  2. Press the desired line key.  
*-The line and CONF keys light. You are connected to the two parties. No more than two extensions in the Privacy Group can join the same call. You cannot enter a Conference call using these steps.*

- To select privacy for the call you are on:** (Do Not Hang Up.)
1. Press the line key of the call you are on.  
*-You have privacy for the call.*

### Removing Lines and Extensions

 **This feature is for attendants only.**

If a line or extension is causing an Alarm, you can remove it from service until service personnel resolve the problem. This prevents further Alarms on this line or extension. After it is repaired, you can place the line or extension back in service.

- To remove a line or extension from service:**
1. Lift handset.
  2. Press ICM.
  3. Press PGM#.
  4. Dial extension number or line extension number.  
*-For example, line 801 is line extension number 372.*
  5. Dial 0.
  6. Hang up.

- To place a line or extension back into service:**
1. Lift handset.
  2. Press ICM.
  3. Press PGM#.
  4. Dial extension number or line extension number (e.g., 372).

## Ringing Line Preference

Ringing Line Preference lets you answer outside calls by just lifting the handset. Ringing Line Preference simplifies the way you answer calls. This helps if you use your phone primarily for answering calls. If more than one call is ringing, Ringing Line Preference answers the call on the lowest numbered line first.

- Ⓜ User-Programmable Feature:** You can allow or deny Ringing Line Preference for your extension. Refer to Ringing Line Preference in User-Programmable Features on page 76.

- To answer an outside call:**
1. Lift handset.
    - The line key is lit.
    - To place a call instead of answering the ringing call, preselect a line before lifting the handset.

## Save

You can Save the last number you dial and redial it easily later on. Save normally uses the same line to dial the call unless you select a different line. The system stores the saved number until you Save another number in its place.

- To Save a number any time after placing a call:** (Do Not Hang Up.)
1. Press DIAL.
  2. Press SAVE.
    - The number you Save can be up to 24 digits long.

- To dial a saved number:**
1. Lift handset.  
*-To select a different line, press a line key.*
  2. Press DIAL.
  3. Press SAVE.  
*-The system uses the same line and dials the number.*  
*-If you hear busy tone, press an idle line key. Your call dials out automatically.*

### Selectable Display Messages

You can choose preprogrammed Selectable Display Messages for your extension. Co-workers (with display telephones) calling your extension see the message you select. Your communications manager can tell you about the programmed messages — and the codes you dial to select them. Your system has 16 Selectable Display Messages (00-15).

For example, assume your system has the message, "AWAY ON BUSINESS." You could select this message before going out of town on business. Optionally, you can add digits to the end of the first eight messages. You can use these digits to provide your callers with a phone number where you can be reached.

- To select a Display Message:** (You can program this on a One-Touch Speed Dial key. See page 54.)
1. Lift handset.
  2. Press ICM.
  3. Press PGM#.
  4. Dial M.
  5. Dial 00-63 to choose one of the messages.  
*-You may add digits to the end of messages 00-07.*
  6. Hang up.  
*-MSG flashes slowly.*

- To select a Display Message (by scrolling through the messages):**
1. Lift handset.
  2. Press ICM.
  3. Press PGM#.
  4. Dial M.
  5. Scroll through the messages using VOL UP or VOL DN.  
*-You may add digits to the end of messages 00-07.*
  6. Press DIAL and SAVE.  
*-You hear dial tone.*  
*-If you append a message (00-07), skip this step.*
  7. Hang up.  
*-MSG flashes slowly.*

- To cancel a Display Message:** (You can program this on a One-Touch Speed Dial key. See page 54.)
1. Lift handset.
  2. Press ICM.
  3. Press PGM#.
  4. Hang up.  
*-MSG goes out.*

## Speed Dial

Speed Dial gives you quick access to frequently called numbers. There are two types of Speed Dial: Personal and System. Each Speed Dial number can be up to 16 digits long. You can chain (link) two Speed Dial numbers to access longer numbers (up to 32 digits).

### Personal Speed Dial

Personal Speed Dial numbers are reserved for your own use. You can store up to 20 Personal Speed Dial numbers in memory locations called bins. Your Personal Speed Dial bins are numbered 50-59 and 20-29. By pressing DIAL, your programmable keys become Personal Speed Dial keys for bins 50-59 and 20-25.

### One-Touch Speed Dial Keys

Your phone may have keys programmed for One-Touch Speed Dial. Just press these One-Touch Speed Dial keys to dial the stored number. (If you have a DSS Console, you can also have One-Touch Speed Dial keys on your console.) You can also store certain Intercom features under your One-Touch Speed Dial keys. This simplifies accessing features that you use often. Just press the One-Touch Speed Dial key to use the key's programmed feature. You can store any feature that uses the digits 0-9, # and \*. Ask your communications manager if you have any One-Touch Speed Dial keys. If you do, you can change the numbers stored for those keys. See the instructions for storing Personal Speed Dial numbers on page 55 for more.

### Storing Names

Optionally, you can store a name with each Personal Speed Dial number. The name displays on your telephone as the number dials out. You can also use this name with the Directory Dialing feature.

### Storing a Pause, Delay or Flash

You can store a *Pause* in a Speed Dial bin by pressing HOLD where you want the Pause to occur. When you use the stored number, the system stops dialing when it encounters the pause and waits for a second dial tone. If the second dial tone occurs, dialing continues. You might want to use a Pause if your Speed Dial number calls a dial-up service (like a banking service) that automatically returns second dial tone. The pause ensures that your number doesn't dial out too soon. (If you don't get second dial tone, you can always dial \* to force the remaining digits to dial out.)

In some cases, you may want to store a **Delay** in lieu of a Pause. A Delay is a fixed wait interval that doesn't monitor for second dial tone. Use Delay, for example, if you're not sure the dial-up service will return second dial tone. After the first part of your Speed Dial bin dials out, the system waits the Delay interval and then dials the remaining digits. To enter a Delay while programming the Speed Dial bin, press DIAL where you want the Delay to occur.

You can also store a **Flash** command in a Speed Dial bin. You might want to do this if your system is behind a Centrex or PBX and you need to use certain Centrex or PBX features. For example, a Flash command frequently initiates a PBX Transfer. To enter the Flash command while programming the Speed Dial bin, press MSG where you want the Flash to occur.

### System Speed Dial

System Speed Dial numbers are accessible from any extension. If you are an attendant, you normally can store or change these System Speed Dial numbers. If you are not an attendant, you normally cannot change these numbers. Check with your communications manager to see what your System Speed Dial numbers are.

### Using Personal Speed Dial

- ① **User-Programmable** You can also use Speed Dial in  
**Feature:** User-Programmable Features to store  
 Personal Speed Dial numbers. See page 54.  
 You must use the User-Programmable  
 procedure to store numbers on One-Touch  
 Speed Dial keys.

- To store a Personal Speed Dial number:**
1. Lift handset and press DIAL.  
 -If you are not an attendant, skip this step if you are programming a One-Touch Speed Dial key.
  2. Press PGM#.  
 -Your display shows, "ENTER BIN #".

3. Dial Personal Speed Dial bin number (50-59, 20-29), press Speed Dial bin key (1-16), or press One-Touch Speed Dial key.
  - Your display shows, "LINE [01-nn,9X]."
  - If you are an attendant, you cannot use this procedure to store numbers in One-Touch Speed Dial keys.
  - Your first Personal Speed Dial key is bin 50; your last is bin 29.
  - If your display shows, "PROGM NAME Y/N," see instructions below for name programming.
4. Dial line number (e.g., 01), press line key or press ICM (to store an Intercom feature).
  - You may also be able to dial a line group code (9, or 90-98) or press a loop key.
  - If you are storing an outside number, your display shows, "TEL NUMBER."
  - If you are storing a feature code, your display shows, "ENTER FEAT. CODE."
5. Dial number.
  - To enter a pause, press **HOLD**. To enter a Flash, press **MSG**. To enter a Delay, press **DIAL**.
  - For example, to have the system dial 9, pause and then dial 926 5400, enter: 9 (HOLD) 9265400.
6. Hang up.

To program a name for a Speed Dial number (when your display shows **PROGM NAME Y/N ?**):

1. Press **Y** to program the name, **N** to leave the name as it is.
  - If you press **Y**, the display shows the current name.
2. Dial the first letter of the desired name.

- To enter a blank (a space), a Q, or a Z, press 0 (zero). To erase a name, press \*.
3. Dial the digit (1, 2 or 3) that identifies the desired letter.
  4. Repeat the above two steps for additional letters.
    - You can correct a name as you enter it. Press VOL DN to backspace (erase) over a character, then enter the correct letters.
  5. Press PGM# when finished.

**To call a Personal Speed****Dial number:**

1. Lift handset.
  - You can preselect a line by pressing a line key. If you preselect, you must press ICM instead of DIAL before dialing a bin number.
2. Press DIAL.
3. Dial Personal Speed Dial bin number or press Personal Speed Dial key.
  - The Speed Dial key does not light.
  - If the number includes a pause, you can press \* to force dialing to continue.
  - If you hear busy tone, press an idle line key. Your call dials out automatically.

**OR**

1. Lift handset.
  - You can preselect a line by pressing a line key.
2. Press One-Touch Speed Dial key.
  - If the number includes a pause, press \* to force dialing to continue.
  - If you hear busy tone, press an idle line key. Your call dials out automatically.

### Using System Speed Dial

**User-Programmable Feature:** You can also use Speed Dial in User-Programmable Features to store System Speed Dial numbers. See page 76.

- To store a System Speed Dial number:**
1. Lift handset.
  2. Press DIAL.
  3. Press PGM#.
  4. Dial System Speed Dial bin number (e.g., 700).  
*-If you display shows, "PROGM NAME Y/N," see instructions above for name programming.*
  5. Dial line number (e.g., 01) or press line key.  
*-You may also be able to dial a line group access code (9, or 90-98) or press a loop key.*
  6. Dial number.  
*-To enter a pause, press HOLD. To enter a Flash, press MSG. To enter a Delay, press DIAL. For example, to have the system dial 9, pause and then dial 926 5400, enter: 9 (HOLD) 9265400.*
  7. Hang up.

- To call a System Speed Dial number:**
1. Lift handset.  
*-You can preselect a line by pressing a line key. If you preselect, press ICM instead of DIAL before dialing a bin number.*
  2. Press DIAL.
  3. Dial System Speed Dial bin number.  
*-If the number includes a pause, you can press \* to force dialing to continue.*

*-If you hear busy tone, press an idle line key. Your call dials out automatically.*

**OR**

1. Lift handset.  
*-You can preselect a line by pressing a line key.*
2. Press System Speed Dial key (One-Touch key for System Speed Dial).  
*-The Speed Dial key does not light.*  
*-If the number includes a pause, you can press \* to force dialing to continue.*  
*-If you hear busy tone, press an idle line key. Your call dials out automatically.*

**To chain two Speed Dial numbers:**

1. Place first call using Speed Dial.  
*-Wait for number to dial out.*
2. Press DIAL.
3. Press Speed Dial key of second number.  
*-Do not dial a bin number.*

**OR**

1. Place first call using Speed Dial.  
*-Wait for number to dial out.*
2. Press One-Touch Speed Dial key of second number.

**OR**

1. Place first call using Speed Dial.  
*-Wait for number to dial out.*
2. Press ICM.
3. Dial Speed Dial bin number (50-59, 20-29).

## Station Call Coverage

A Station Call Coverage key gives you one-touch call pickup, Transfer and Intercom for the assigned extension. A Call Coverage key also shows you the status of the covered extension.

## Station Call Coverage

When the key is . . .	The covered phone is . . .
OFF	Idle
ON	Busy
Flashing Slowly	Ringling
Flashing Fast	In DND

- To place a call to your covered extension:**
1. Press Call Coverage key.
  2. If you hear two beeps, go ahead and speak.
  3. If you hear ringing, wait for called party to answer.

- To Transfer a call to a covered extension:**
1. Press Call Coverage key.
  2. If you hear two beeps, announce call.

***OR***

If you hear ringing, wait for called party to answer before announcing call.

***OR***

Hang up to Transfer the call unannounced.

***OR***

If you hear ring/busy, dial 1 to send Off-Hook Signaling. Refer to the Off-Hook Signaling feature.

**To pick up a call ringing a covered extension:** 1. Press flashing Call Coverage key.

- ① **User-Programmable Feature:** Use Ring Assignment and Delayed Ring Assignment in User-Programmable Features (page 76) to program ringing for your Call Coverage keys. To change a Call Coverage Key extension assignment, use DSS programming. See DSS in User-Programmable Features (page 76).

## **Telemarketing Dial**

Telemarketing Dial lets you use your PC to dial a call and then pick up the call from your telephone after it goes through. If you have auto-dialing or database dialing capabilities in your PC, you can now use those features to place your voice calls. To use Telemarketing Dial, you must have your PC connected to a modem and an Analog Station Interface (ASI). You must also have a Call Coverage key for the ASI. Ask your communications manager if you can use Telemarketing Dial.

- To use Telemarketing Dial:**
1. Use your PC's communications software Directory Dialing feature to place the call.
    - Listen to the call dialing out through your modem.*
  2. When the called party answers, press the Call Coverage key for your PC.
    - The call will be in the Privacy Release mode (the line key flashes fast). To enable privacy, press the line key.*

## **Time and Date**

The time and date appear on display phones.

- ① **User-Programmable Feature:** You may be able to set the time and date using Time and Date in User-Programmable

Features (page 76). If you are an attendant, you can also use the procedure below.

- To set the time:**
1. Lift handset.
  2. Press ICM.
  3. Press PGM#.  
*-Your display shows, "DSS,EXT,6,9,8?."*
  4. Dial T.  
*-Your display shows, "SET TIME  
HHMMSS."*
  5. Enter the hour (00-23: 0=12 midnight;  
12=12 noon; 23=11 P.M.)
  6. Enter the minutes (00-59).
  7. Enter the seconds (00-59).
  8. Hang up.

- To set the date:**
1. Lift handset and press ICM.
  2. Press PGM#.  
*-Your display shows, "DSS,EXT,6,9,8?."*
  3. Dial 9.  
*-Your display shows, "SET DATE  
MMDDYY."*
  4. Enter the month (01-12, 01=January;  
12=December).
  5. Enter the day of the month (01-31).
  6. Enter the last two digits of the year (00-99).
  7. Hang up.

## Voice Mail

Your system may have Voice Mail (Integrated Voice Messaging). Integrated Voice Messaging lets you exchange recorded messages with co-workers. It also lets your outside callers leave recorded messages for you. You and every other user has a mailbox which holds your recorded messages. You "call your mailbox" to listen to your messages and use other Integrated Voice Messaging features.

## **Call Forwarding to Voice Mail**

When you forward your phone to Voice Mail, your incoming calls automatically go to your mailbox. Your callers can leave a message instead of calling back later. You can choose one of three different Call Forwarding to Voice Mail modes:

- Forward calls you do not answer
- Forward calls when you are busy and calls you do not answer
- Forward all your calls

## **Personal Answering Machine Emulation**

Your mailbox may be able to emulate a personal answering machine. This lets you screen your calls, just like your answering machine at home. You can let the message go through or lift the handset to pick up the call.

## **Leaving a Message**

When you call a co-worker and their phone is unanswered, busy or in Do Not Disturb, you can easily leave a message in their mailbox. You don't have to call back later.

## **Transfer to Voice Mail**

Transfer a call to your own or a co-worker's mailbox. After the Transfer goes through, your caller can leave a message in the mailbox.

## **Message Center**

A Message Center is a mailbox shared by you and your co-workers. If your phone has a Message Center key, you can leave messages for your co-workers or listen to messages they have left. For example, you could be part of a Customer Service group with a Message Center for each of your company's products. When all members of your group are busy, your dispatcher can send callers to the appropriate Message Center. Later on, you can easily retrieve all messages for a particular product. Ask your communications manager if your phone has a Message Center key.

### Conversation Record

While on a call, you can press your Record key to record the conversation in your mailbox. Voice Mail stores the conversation like any other voice message. You can then save, edit or delete the recorded conversation. Ask your communications manager if you have a record key.

- To call your mailbox:**
1. Lift handset.
  2. Press MSG.
  3. When Integrated Voice Messaging answers, dial your security code.  
*-Your communications manager can tell you your security code. Refer to your Voice Mail User Guide for the specifics. You can have a One-Touch Speed Dial key for simplified security code entry. See page 54.*

- To call a Message Center:** (If the Message Center key flashes fast, it has messages waiting.)  
*-You cannot press the flashing Message Center key to see the number of messages waiting.*
1. Lift handset.
  2. Press the Message Center key.  
*-You log onto the Message Center mailbox. You have all the options available to any other mailbox subscriber.*

- To forward calls to your mailbox:**
1. Lift handset.
  2. Press ICM.
  3. Press PGM#.
  4. Press MSG.
  5. Dial Call Forwarding option.  
*-Dial 1 to forward calls not answered.*

*-Dial 2 to forward calls not answered or when busy.*

*-Dial 3 to forward all calls.*

*-Dial 4 to have Voice Mail screen your calls (i.e., emulate a personal answering machine).*

6. Hang up.

*-MSG flashes slowly.*

**To cancel Call Forwarding:** 1. Lift handset.

2. Press ICM.

3. Press PGM#.

4. Hang up.

*-MSG goes out.*

**To Transfer a call to someone else's mailbox:** 1. Press ICM.

2. Press MSG.

3. Dial extension number.

*-If you dial the Voice Messaging System master number, your outside caller can select the mailbox they want.*

4. Hang up.

**To record your conversation:** (Your telephone must have a record key.)

1. Press Record key.

*-After a few seconds, you hear two beeps and an announcement when Voice Mail starts recording your call. The record key flashes fast while recording.*

## Voice Prompting Messages

The system plays Voice Prompting Messages to inform a user of the status of their call. See your communications manager for a complete explanation of these messages.

## Voice Prompting Messages

<b>Voice Prompt</b>	<b>Description</b>
<i>All lines are busy. For automatic Callback, please press the Callback key.</i>	Plays when trying to place a call when all lines in the group are busy.
<i>Audio file is full.</i>	Plays when trying to record a Personal Greeting when all memory has been used.
<i>Please do not disturb.</i>	Plays when calling an extension in DND.
<i>Please hold on, all lines are busy. Your call will be answered when a line becomes free.</i>	Plays when calling a busy UCD or ACD hunt group.
<i>Please hold on, your call is being rerouted.</i>	Plays when calling an extension that is Call Forwarded off-premise.
<i>Please start recording.</i>	Plays to prompt the user to record a Personal Greeting.
<i>Recording finished.</i>	Plays to alert the user that the time allotted for recording a Personal Greeting is up. Also plays when the user has paused too long while recording a Personal Greeting.
<i>The lowest cost line is busy. Please wait for the next one.</i>	Plays when placing an ARS call when all lines in a line group are busy.
<i>The number you have dialed is not in service.</i>	Plays when calling a valid, but inoperative extension.
<i>The time is ....</i>	Plays the time after dialing T (digit 8) on an idle telephone.
<i>This is station ....</i>	Plays the extension number after dialing N (digit 6) on an idle telephone.

Voice Prompt	Description
<i>You have a message.</i>	Plays to alert the user that someone has left a Message Waiting (controlled by system programming).
<i>Your call cannot go through. Please call the operator.</i>	Plays when trying to place a restricted call.
<i>Your calls have been forwarded.</i>	Plays to alert the user that the extension's calls have been forwarded (controlled by system programming).
<i>Vacant number.</i>	Plays when calling an invalid (not installed) extension.

## Volume Controls

Your telephone has three volume adjustments: Background Music, handset and Handsfree. The Background Music adjustment also adjusts incoming ringing and paged announcements. If you are an attendant, you don't have Handsfree or the Handsfree volume adjustment.

- To adjust the volume of Background Music, incoming ringing and paged announcements:**
1. Press VOL UP or VOL DN while feature is active or telephone is idle.  
-Pressing VOL UP or VOL DN while idle adjusts the display brightness. Your phone must be idle (not ringing), with Background Music off.

- To adjust the handset volume:**
1. Press VOL UP or VOL DN while on a handset call.

*-When you hang up, the volume level for outside calls may revert to a mid-range value. The volume level for Intercom calls, however, stays at the set value until you change it.*

**To adjust the Handsfree (speaker) volume:**

1. Press VOL UP or VOL DN while on a Handsfree call.

*-When you hang up, the volume level for outside calls may revert to mid-range. The volume level for Intercom calls, however, stays at a set value until you change it.*

*-The volume level setting for the previous Handsfree Intercom call determines the volume of your incoming voice announcements.*

## Walking Class of Service

If you try to place a call from a co-worker's phone and the system prevents it, you can use Walking Class of Service. Walking Class of Service allows you to temporarily override dialing restrictions when you use someone else's extension. Walking Class of Service lets you make the call as you would at your own extension.

**To place a call from a restricted extension:**

1. Lift handset and press ICM.
2. Press PGM# twice.
3. Dial Walking Class of Service code.  
*-See your communications manager for your code.*
4. Dial line access code (e.g., 801), or press line key.  
*-You may also be able to dial a line group access code (9, 90-98).*
5. Dial telephone number.

## □ Charts and Illustrations

This section contains handy charts and illustrations for your reference. You'll find:

- The dialing plan (the numbers you dial) — see below
- Flash rates for graphite telephones with dual color (red and green) LEDs — see page 70
- Flash rates for telephones with single color (red) LEDs — see page 71
- Multibutton telephone key layout — see page 72
- DSS Console key layouts for (page 73)
- Feature Quick Reference Guide — see page 75
- User-Programming chart — see page 76

### Your System's Dialing Plan

This chart shows the numbers you dial for extensions, outside lines, Ring Groups and Selectable Display Messages.

	Without AUX	With AUX
<b>Extensions</b>	300-323	300-371
<b>Outside Lines</b>	801-808	801-824
<b>Outside Line Codes</b>	01-08	01-24
<b>Outside Line Groups</b>	9, 90-98	9, 90-98
<b>Outside Line Extensions</b>	348-355	372-395
<b>Ring Groups</b>	364-371	396-403
<b>Selectable Display Messages</b>	00-15	00-15

<b>Graphite Phone with Dual Color LEDs</b>	
<i>Your phone is idle (not on a call)</i>	All LEDs out (dark)
<b>Outside Calls</b>	
<i>An outside line is busy</i>	The line key is <b>On Red</b>
<i>An outside call is ringing your phone</i>	The line key flashes <b>Slowly Red</b> if it's shared, <b>Off</b> then <b>Quickly Flashing Green</b> if it's just for you
<i>And then you answer it</i>	The line key is <b>On Green</b>
<i>Or answer it with Privacy released</i>	The line key flashes <b>Quickly Green</b>
<i>You place the outside call on Hold</i>	The line key is <b>On</b> then <b>Slowly Flashing Green</b>
<i>Or a co-worker places it on Hold</i>	The line key flashes <b>Moderately Red</b>
<i>Or you place the outside call on Exclusive Hold</i>	The line key is <b>On</b> then <b>Quickly Flashing Green</b>
<i>If a call on Hold recalls to you</i>	The line key is <b>Off</b> then <b>Quickly Flashing Green</b>
<b>Intercom Calls</b>	
<i>An Intercom call rings your phone</i>	ICM flashes <b>Slowly Green</b>
<i>You answer the Intercom call</i>	ICM flashes <b>Quickly Red</b>
<i>You place the Intercom call on Hold</i>	HOLD flashes <b>Quickly Green</b> then <b>On</b>
<i>And then it recalls to you</i>	ICM flashes <b>Slowly Green</b>
<b>Miscellaneous Features</b>	
<i>You activate Microphone Mute</i>	MIC/DND is <b>On Red</b>
<i>You activate Do Not Disturb</i>	MIC/DND flashes <b>Quickly Red</b>
<i>You have a Message Waiting</i>	MSG flashes <b>Quickly Red</b>
<i>You activate Call Forwarding, Personal Greeting or Selectable Display Messaging</i>	MSG flashes <b>Slowly Green</b>

<b>Phone with Single Color (Red) LEDs</b>	
<i>Your phone is idle (not on a call)</i>	All LEDs out (dark)
<b>Outside Calls</b>	
<i>An outside line is busy</i>	The line key is <b>On</b>
<i>An outside call is ringing your phone</i>	The line key flashes <b>Slowly</b> if it's shared, <b>Off</b> then flashing <b>Quickly</b> if it's just for you
<i>And then you answer it</i>	The line key is <b>On</b>
<i>Or answer it with Privacy released</i>	The line key flashes <b>Quickly</b>
<i>You place the outside call on Hold</i>	The line key is <b>On</b> then flashing <b>Moderately</b>
<i>Or a co-worker places the call on Hold</i>	The line key flashes <b>Moderately</b>
<i>Or you place the outside call on Exclusive Hold</i>	The line key is <b>On</b> then flashing <b>Quickly</b>
<i>If a call on Hold recalls to you</i>	The line key is <b>Off</b> then flashing <b>Quickly</b>
<b>Intercom Calls</b>	
<i>An Intercom call rings your phone</i>	ICM flashes <b>Slowly</b>
<i>You answer the Intercom call</i>	ICM flashes <b>Quickly</b>
<i>You place the Intercom call on Hold</i>	HOLD is <b>ON</b> then flashes <b>Quickly</b>
<i>And then it recalls to you</i>	ICM flashes <b>Slowly</b>
<b>Miscellaneous Features</b>	
<i>You activate Microphone Mute</i>	MIC/DND is <b>On</b>
<i>You activate Do Not Disturb</i>	MIC/DND flashes <b>Quickly</b>
<i>You have a Message Waiting</i>	MSG flashes <b>Quickly</b>
<i>You activate Call Forwarding, Personal Greeting or Selectable Display Messaging</i>	MSG flashes <b>Slowly</b>

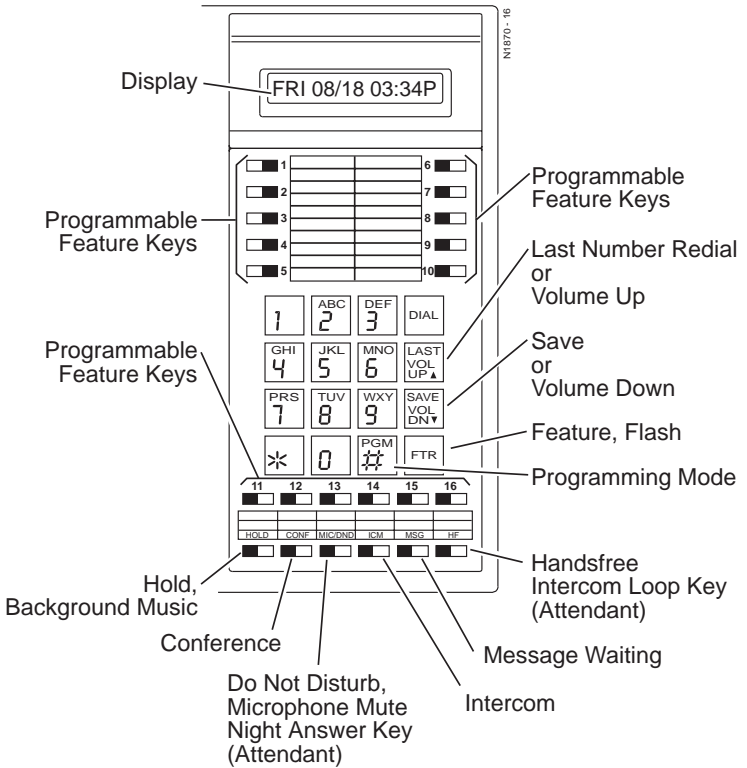

## Your Multibutton Telephone

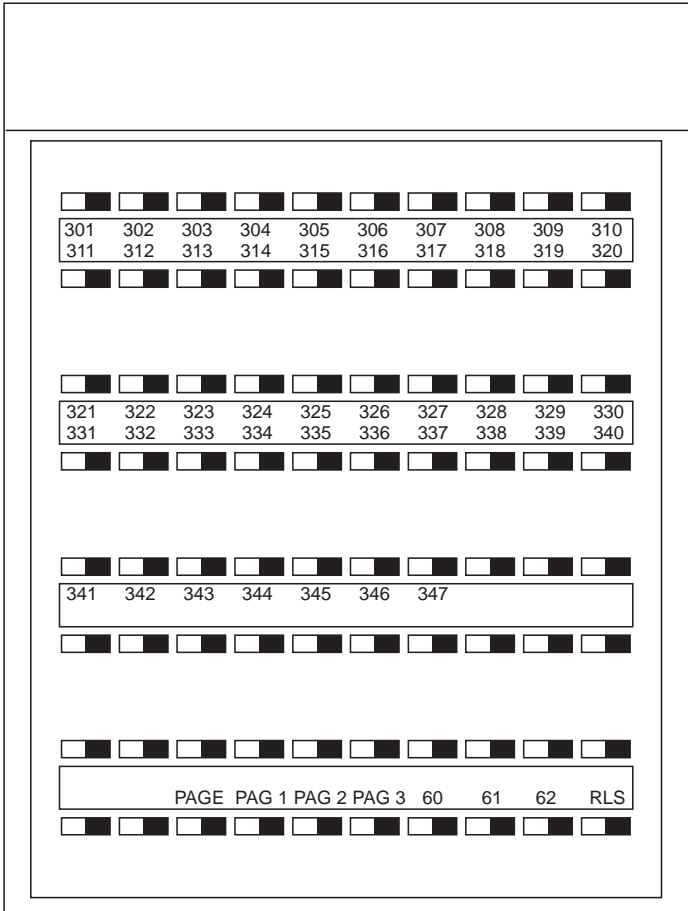

**Your DSS Console**



QUICK REFERENCE	
<b>OUTSIDE CALLS</b>	
<b>Placing:</b>	Lift handset + Line key + Dial number
<b>Answering:</b>	Lift handset (if not connected, press flashing key)
<b>Answering ringing over paging speakers:</b>	Lift handset + ICM + Dial * 0
<b>INTERCOM CALLS</b>	
<b>Placing:</b>	Lift handset + ICM + Dial extension (if you hear ring-busy, you may be able to dial 1 to get through)
<b>Answering:</b>	If ringing, lift handset. If announced, speak toward phone or lift handset.
<b>HOLD</b>	
<b>Placing call on Hold:</b>	HOLD + Hang up
<b>Retrieving call:</b>	Lift handset + Flashing line key for outside call (or ICM, then HOLD key)
<b>TRANSFER</b>	
<b>Transferring outside call:</b>	ICM + Dial ext. + Announce call + Hang up
<b>CONFERENCE</b>	
<b>Setting up a three-way conversation:</b>	Establish an outside/Intercom call + CONF + Establish next call + CONF
<b>RESPONDING TO SIGNAL TONES</b>	
<b>Two tones during handset call:</b>	Then you hear a co-worker's voice over your call. To reply, press and hold MIC/DND.
<b>One tone during speakerphone call:</b>	This means a call is waiting to be answered. Press HOLD + Flashing ICM or line key.
<b>Fast busy or warble tone anytime:</b>	This means you made a mistake in placing a call or using a feature. Hang up and start over.

## DS01 USER-PROGRAMMABLE FEATURES

To program a feature, press PGM# and the feature's code. For example, to set Night Ring, press PGM# and dial NR. The remaining steps vary with each feature. Your access level determines the features you can program. See your communications manager. Note that enabling RA or NR disables DRA and vice versa. To disable ringing, disable NR, RA *and* DRA.

<b>DELAYED RING ASSIGNMENT</b>	PGM# + <b>DRA</b> + Line key + <b>Y(es)</b> or <b>N(o)</b> + SAVE
<b>DSS</b>	PGM# + <b>DSS</b> + DSS key + ext. + SAVE
<b>HEADSET</b>	PGM# + <b>HS</b> + <b>Y(es)</b> or <b>N(o)</b> + SAVE
<b>HOTLINE</b>	PGM# + <b>HL</b> + Hotline key + ext. + SAVE
<b>NIGHT RING</b>	PGM# + <b>NR</b> + Line key + <b>Y(es)</b> or <b>N(o)</b> + SAVE
<b>PAGE</b>	PGM# + <b>VP</b> + <b>Y(es)</b> or <b>N(o)</b> + SAVE
<b>PRIME LINE</b>	PGM# + <b>PLA</b> + Line key + <b>Y(es)</b> or <b>N(o)</b> + SAVE
<b>RING ASSIGNMENT</b>	PGM# + <b>RA</b> + Line key + <b>Y(es)</b> or <b>N(o)</b> + SAVE
<b>RINGING LINE PREFERENCE</b>	PGM# + <b>RLP</b> + <b>Y(es)</b> or <b>N(o)</b> + SAVE
<b>SPEED DIAL</b>	PGM# + <b>SD</b> + One-Touch Speed key (or bin + PGM#) + (Display set only) Name or PGM# + line key (or line/group code + PGM#) or ICM + number (32 digits max.) + SAVE
<b>TIME AND DATE</b>	PGM# + <b>TD</b> + Month (01-12) + PGM# + Date (1-31) + PGM# + Year (2 digits) + PGM# + Hour (00-23) + PGM# + Minutes (00-59) + SAVE
<b>VOICE ANNOUNCE</b>	PGM# + <b>VA</b> + <b>Y(es)</b> or <b>N(o)</b> + SAVE
<b>WHISPER PAGE</b>	PGM# + <b>VO</b> + <b>Y(es)</b> or <b>N(o)</b> + SAVE



# Index

## A

- Account Codes, 14
  - Mandatory, 14
  - Verifiable, 14
- ACD
  - Agent (Member), 17
  - Announcements, 18
  - Group Status, 17
  - On and Off Duty, 17
  - Recording Announcements, 18
  - Supervisor, 17
- ACD Agent, Removing from Service, 17, 18
- Add-On Conference, 25
- Alarm, 15
- Alphanumeric Display
  - Display Brightness, 30
  - Introduction to, 2
  - Messages, 30
- Alternate Attendant, 16
- Answering Intercom Calls, 10
- Answering Machine Emulation, 63
- Answering Outside Calls, 8
- ARS, 8
- Assigned Night Answer
  - See Night Answer
- Attendant Alarm Messages, 15
- Attendant Call Forwarding Cancel, 21
- Attendant Features Only
  - Alarm, 15
  - Alternate Attendant, 16
  - Call Forwarding Cancel, 21
  - Forced Line Disconnect, 33
  - Monitor, 41
  - Night Answer, 42
- Attendant Monitor

- See Monitor
- Attendant, Features not available to
  - Call Forwarding, 20
  - Callback, 22
  - Do Not Disturb, 31
  - Group Listen, 34
  - Handsfree, 7
  - Handsfree Volume Adjustment, 67
  - ICM Key, 10
  - Line Callback, 38
  - Message Waiting, Receiving, 40
  - Microphone Mute, 41
  - Personal Greeting, 48
  - Voice-announced calls, 10
  - Whisper Page, 43
- Audio Prompts, 65, 66
- Audio Volumes, 67
- Automated Attendant, 44
- Automatic Redial
  - See Last Number Redial
- Automatic Route Selection, 8

## B

- Background Music
  - Volume Control, 67
- Barge In, 37
- Brightness
  - Adjusting the Display, 31

## C

- Call Coverage, 59, 60
- Call Forwarding, 20
  - Cancelling, 20
  - Off-Premise, 21
  - On-Premise, 20
  - To mailbox, 64
- Call Forwarding at Attendant
  - See Alternate Attendant

- Call Forwarding Cancel, 21
- Call Park, 47
- Call Pickup
  - Group, 33
  - Group Ring, 34
  - Hotline, 36
- Call Pickup, Directed, 28
- Call Timer, 21
  - Auto, 22
  - Manual, 22
- Call Waiting
  - See Camp-On
- Callback, 22
  - Cancelling, 23
  - Line, 38
- Called Number Delivery (CND)
  - See Caller ID
- Called Number Identification (CNI)
  - See Caller ID
- Caller ID, 23
  - Error Messages, 24
  - Post-Answer Display, 23
  - Pre-Answer Display, 23
- Calling a Message Center, 64
- Calling your mailbox, 64
- Camp-On, 24
- Centrex Feature Keys
  - See your communications manager.
- Chaining Speed Dial Numbers, 59
- Class of Service
  - See Walking Class of Service
- Conference, 25
  - Meet Me, 39
  - Unsupervised, 26
- Conversation Record Key, 64

## D

- Database Dialing
  - See Telemarketing Dial
- Date and Time, 61
- Delayed Ringing, 76
- Dialing 9 or 90-98, 8
- Dialing Behind a PBX or Centrex, 8
- Dialing from the PC
  - See Telemarketing Dial
- Dialing Number Preview, 26
- Dialing Plan, 69
- Digital Door Box, 31
- Direct Line Access, 8
- Direct Station Selection, 27
- Directed Call Pickup, 28
- Directory Dialing, 29
  - Company-wide, 29
  - Intercom, 29
  - Personal, 29
- Disabling Lines and Extensions, 50
- Display
  - Adjusting the display brightness, 31
- Display Messages, 30, 52
- DND
  - See Do Not Disturb
- Do Not Disturb, 31
- Door Box, 31
- DSS
  - See Direct Station Selection

## E

- Exclusive Hold, 10
- Executive Override
  - See Intrusion
- Extension Speed Dial, 54
- External Paging, 45, 46

**F**

Flash, 32

Flash Rates

    Call Coverage key, 60

    Group Call Pickup Key, 34

    Hotline Key, 36

    Page key, 47

    Park key, 48

    Personal Speed Dial key, 57

    Record Key, 65

    System Speed Dial key, 59

    Timer key, 22

Forced Account Codes

    See Account Codes, Mandatory

Forced Trunk Disconnect, 33, 41

Forwarding calls to your mailbox, 64

**G**

Group Call Pickup, 33

Group Listen, 34

Group Ring, 34

Groups

    Call Pickup, 33

    Privacy, 50

**H**

Headset Mode, 35

Hold, 10, 11

    Exclusive Hold, 10

    Intercom, 12

    System Hold, 10

Hotline, 36

**I**

Intercom, 9

Internal Paging, 45, 46

Intrusion, 37

## L

- Last Number Redial, 38
- Line Callback, 38
- Line Rotaries
  - Inbound, 8
  - Outbound, 8
- Loop Keys
  - Inbound, 8
  - Outbound, 8

## M

- Mandatory Account Codes, 14
- Meet Me Conference, 39
- Message Center, 63
- Message Waiting, 40
- Microphone Mute, 41
- Monitor, 41
- Multi-Line Conference, 25
- Multi-Party Conference, 25
- Music On Hold
  - Volume Control, 67

## N

- Night Answer, 42
- Night Service
  - See Night Answer
- Number Save, 51

## O

- Off-Hook Signaling, 43
- Off-Premise Call Forwarding, 21
- One-Touch Speed Dial keys, 54
- Operator Assistance, 44
- Outside Calls
  - Answering, 8
- Overriding Toll Restriction, 68

**P**

- Page, Zone, 45, 46
- Paging
  - Volume Control, 67
- Park, 47
- PBX/Centrex Dialing, 8
- PC Dialing
  - See Telemarketing Dial
- Personal Answering Machine Emulation, 63
- Personal Greeting, 48
- Personal Speed Dial, 54
- Placing Intercom Calls, 9
- Placing Outside Calls, 7
- Prime Line Selection, 49
- Privacy, 50
- Privacy Groups, 50
- Privacy Release, 50
- Prompts, Voice, 65, 66

**R**

- Record Key (for Voice Mail), 64
- Recording
  - ACD (All Agents Busy) Overflow Announcement, 18
  - OPA Messages, 44
  - Personal Greeting, 49
- Redial, Last Number, 38
- Removing ACD Agent from Service, 17, 18
- Removing Lines and Extensions from Service, 50
- Ring Groups, 34
- Ringling
  - Volume Control, 67
- Ringling Assignments, 76
- Ringling Line Preference, 51
- Ringling, Off-Hook
  - See Off-Hook Signaling
- Rotaries, Line, 8

## S

- Save, 51
- Selectable Display Messages, 52
- Setting the Time and Date, 61
- Silent Monitor
  - See Monitor
- Speed Dial, 53, 54, 55, 56, 57, 58
  - Chaining Numbers, 59
  - One-Touch Speed Dial Keys, 54
  - Personal Speed Dial, 53, 54, 55, 56, 57, 58
  - Storing a Pause, Delay or Flash, 54
  - Storing Intercom Features, 54
  - Storing Names, 54
  - System Speed Dial, 55
  - Using Personal Speed Dial, 55
  - Using System Speed Dial, 58
- Split
  - Between Camped-On Calls, 25
- Station Call Coverage, 59, 60
- Station-to-Station Calling
  - See Intercom
- Supervisor, ACD, 17
- System Hold, 10
- System Speed Dial, 55

## T

- Tandem Trunking, 26
- Telemarketing Dial, 61
- Text Messaging
  - See Selectable Display Messages
- Tie Lines
  - See your Communications Manager
- Time and Date, 61
- Timed Flash, 32
- Toll Restriction Override, 68
- Transfer, 12, 13
  - To mailbox, 63, 65
  - Transferring Intercom Calls, 12

Trunk Queuing  
See Line Callback

## U

Universal Night Answer  
See Night Answer

Unsupervised Conference, 26

User Programming

- Call Coverage Keys, 61
- Chart, 76
- Delayed Ring Assignment, 7
- Direct Station Selection, 28
- Headset Operation, 36
- Hotline Assignments, 36
- Intercom Voice Announcements, 10
- Night Ringing, 42
- Paging, 46
- Pickup Group Ringing, 34
- Prime Line Selection, 49
- Ring Assignment, 7
- Ringling for Outside Calls, 7
- Ringling Line Preference, 51
- Speed Dial, One-Touch Speed Dial keys, 55
- Speed Dial, Personal Speed Dial Numbers, 55
- System Speed Dial, 58
- Time and Date, 61
- Voice Over, 43

Using Headsets, 35

Using Personal Speed Dial, 55

Using System Speed Dial, 58

## V

Verifiable Account Codes, 14

VMU

- Operator Assistance, 44
- Personal Greeting, 48
- Voice Prompting Messages, 65, 66

Voice Mail

- Answering Machine Emulation, 63
- Calling your mailbox, 64
- Forwarding to mailbox, 63, 64
- Leaving a message, 63
- Message Center, 63
- Record Key, 64
- Transferring to mailbox, 63
- Voice Module Unit
  - See VMU
- Voice Over, 43
- Voice Prompting Messages, 65, 66
- Voice-Announced Calls, 10
- Volume Controls, 67

**W**

- Walking Class of Service, 68
- Whisper Page, 43

**Z**

- Zone Paging, 45, 46



4 Forest Parkway, Shelton, CT 06484  
TEL: 203-926-5400 FAX: 203-929-0535

*Nitsuko*



# Digital System **DS**

## Multibutton Telephone Feature Handbook

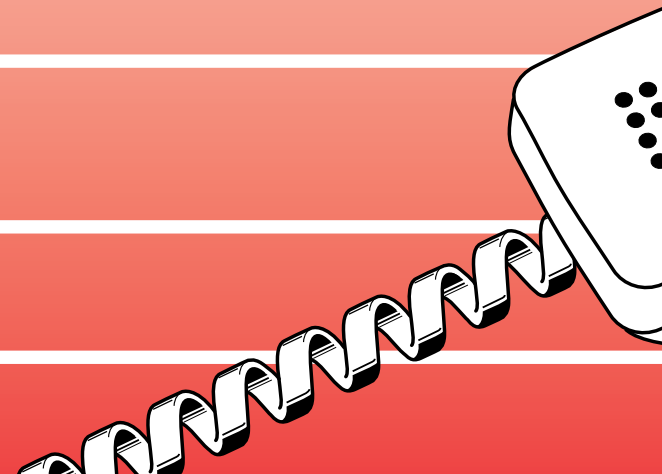

This manual has been developed by Nitsuko America. It is intended for the use of its customers and service personnel, and should be read in its entirety before attempting to install or program the system. Any comments or suggestions for improving this manual would be appreciated. Forward your remarks to:

Nitsuko America, Telecom Division  
4 Forest Parkway  
Shelton, CT 06484

Attention: Manager, Technical Publications

Nothing contained in this manual shall be deemed to be, and this manual does not constitute, a warranty of, or representation with respect to, any of the equipment covered. This manual is subject to change without notice and Nitsuko America has no obligation to provide any updates or corrections to this manual. Further, Nitsuko America also reserves the right, without prior notice, to make changes in equipment design or components as it deems appropriate. No representation is made that this manual is complete or accurate in all respects and Nitsuko America shall not be liable for any errors or omissions. In no event shall Nitsuko America be liable for any incidental or consequential damages in connection with the use of this manual. This document contains proprietary information that is protected by copyright. All rights are reserved. No part of this document may be photocopied or reproduced without prior written consent of Nitsuko America.

©1994 by Nitsuko America. All Rights Reserved.

Printed in U.S.A.